



G·SYSTEM
INTEGRATED EFFECTS & MANAGEMENT

Users Manual
English Version

IMPORTANT SAFETY INSTRUCTIONS



The lightning flash with an arrowhead symbol within an equilateral triangle is intended to alert the user to the presence of uninsulated "dangerous voltage" within the product's enclosure that may be of sufficient magnitude to constitute a risk of electric shock to persons.



The exclamation point within an equilateral triangle is intended to alert the user to the presence of important operating and maintenance (servicing) instructions in the literature accompanying the product.

- 1 Read these instructions.
- 2 Keep these instructions.
- 3 Heed all warnings.
- 4 Follow all instructions.
- 5 Do not use this apparatus near water.
- 6 Clean only with dry cloth.
- 7 Do not block any ventilation openings. Install in accordance with the manufacturer's instructions.
- 8 Do not install near any heat sources such as radiators, heat registers, stoves, or other apparatus (including amplifiers) that produce heat.
- 9 Do not defeat the safety purpose of the polarized or grounding-type plug. A polarized plug has two blades with one wider than the other. A grounding type plug has two blades and a third grounding prong. The wide blade or the third prong are provided for your safety. If the provided plug does not fit into your outlet, consult an electrician for replacement of the obsolete outlet.
- 10 Protect the power cord from being walked on or pinched particularly at plugs, convenience receptacles, and the point where they exit from the apparatus.
- 11 Only use attachments/accessories specified by the manufacturer.
- 12  Use only with the cart, stand, tripod, bracket, or table specified by the manufacturer, or sold with the apparatus. When a cart is used, use caution when moving the cart/apparatus combination to avoid injury from tip-over.
- 13 Unplug this apparatus during lightning storms or when unused for long periods of time.
- 14 Refer all servicing to qualified service personnel. Servicing is required when the apparatus has been damaged in any way, such as power-supply cord or plug is damaged, liquid has been spilled or objects have fallen into the apparatus, the apparatus has been exposed to rain or moisture, does not operate normally, or has been dropped.

Warning!

- To reduce the risk of fire or electrical shock, do not expose this equipment to dripping or splashing and ensure that no objects filled with liquids, such as vases, are placed on the equipment.
- This apparatus must be earthed.
- Use a three wire grounding type line cord like the one supplied with the product.
- Be advised that different operating voltages require the use of different types of line cord and attachment plugs.
- Check the voltage in your area and use the correct type. See table below:

Voltage	Line plug according to standard
110-125V	UL817 and CSA C22.2 no 42.
220-230V	CEE 7 page VII, SR section 107-2-D1/IEC 83 page C4.
240V	BS 1363 of 1984. Specification for 13A fused plugs and switched and unswitched socket outlets.

- This equipment should be installed near the socket outlet and disconnection of the device should be easily accessible.
- To completely disconnect from AC mains, disconnect the power supply cord from the AC receptacle.
- The mains plug of the power supply shall remain readily operable.
- Do not install in a confined space.
- Do not open the unit – risk of electric shock inside.

Caution:

You are cautioned that any change or modifications not expressly approved in this manual could void your authority to operate this equipment.

Service

- There are no user-serviceable parts inside.
- All service must be performed by qualified personnel.

EMC / EMI & CERTIFICATE OF CONFORMITY

EMC/EMI

This equipment has been tested and found to comply with the limits for a Class B Digital device, pursuant to part 15 of the FCC rules.

These limits are designed to provide reasonable protection against harmful interference in residential installations. This equipment generates, uses and can radiate radio frequency energy and, if not installed and used in accordance with the instructions, may cause harmful interference to radio communications. However, there is no guarantee that interference will not occur in a particular installation. If this equipment does cause harmful interference to radio or television reception, which can be determined by turning the equipment off and on. The user is encouraged to try to correct the interference by one or more of the following measures:

- Reorient or relocate the receiving antenna.
- Increase the separation between the equipment and receiver.
- Connect the equipment into an outlet on a circuit different from that to which the receiver is connected.
- Consult the dealer or an experienced radio/TV technician for help.

For Customers in Canada:

This Class B digital apparatus complies with Canadian ICES-003.

Cet appareil numérique de la classe B est conforme à la norme NMB-003 du Canada.

Certificate of Conformity

TC Electronic A/S, Sindalsvej 34, 8240 Risskov, Denmark, hereby declares on own responsibility that the following product:

G-System – Guitar Effects Processor, Loop System and MIDI controller

that is covered by this certificate and marked with CE-label conforms with following standards:

EN 60065 (IEC 60065)	Safety requirements for mains operated electronic and related apparatus for household and similar general use
EN 55103-1	Product family standard for audio, video, audio-visual and entertainment lighting control apparatus for professional use. Part 1: Emission.
EN 55103-2	Product family standard for audio, video, audio-visual and entertainment lighting control apparatus for professional use. Part 2: Immunity.

With reference to regulations in following directives:

73/23/EEC, 89/336/EEC

Issued in Risskov, June 2005
Mads Peter Lübeck
Chief Executive Officer

TABLE OF CONTENTS

INTRODUCTION

<i>Safety Instructions</i>	a
<i>EMC/EMI & Certificate of Conformity</i>	b
<i>Table of contents</i>	3
<i>Introduction</i>	5
<i>Quick setup guide</i>	8
<i>Menu Hierarchy</i>	13

OVERVIEW

<i>Control Board – Top</i>	14
<i>Control Board – Rear</i>	18
<i>GFX01 – Front</i>	18
<i>Mounting G-System in a pedal-flightcase</i> ..	19
<i>GFX01 – Rear</i>	20

SETUPS

<i>Explanation of amp-types</i>	22
<i>G-System on the floor:</i>	
<i>Pedals + amp</i>	23
<i>Pedals + pre-amp + amp</i>	24
<i>Pedals + head</i>	25
<i>3-way system</i>	26
<i>Dual Amp</i>	27
<i>G-System split with “GFX01” in a rack</i> ..	28
<i>Additional setup information</i>	29

GENERAL OPERATION

Play Mode & Edit Mode

<i>Play Mode</i>	30
<i>Edit Mode</i>	31
<i>Selecting effect types</i>	31

Preset Handle mode

<i>Store presets</i>	32
<i>Delete presets</i>	33
<i>Copying effects between presets</i>	33

MENU MODE

<i>Overview</i>	32
-----------------------	----

Routings

<i>Serial Routing</i>	35
<i>Semi Parallel routing</i>	35
<i>Parallel Routing</i>	36
<i>Routing Lock</i>	37
<i>Input Select</i>	37

Levels

<i>Optimizing your noise level</i>	38
<i>Level parameters</i>	38
<i>Boost Function</i>	39

Pedals

<i>Expression pedals – for what?</i>	40
<i>Connecting</i>	40
<i>Setting up your pedals</i>	40
<i>Pedals menu</i>	41
<i>Volume function – Expression function</i> ..	42
<i>Calibrating</i>	42
<i>Letting expression pedals control specific parameters</i>	43

Switches

<i>Custom Setup of Switch functions</i>	44
---	----

MIDI

<i>MIDI related parameters</i>	46
<i>Backup via MIDI</i>	46

Utility

<i>Tap Master</i>	47
<i>Lock parameters</i>	47
<i>Clear parameters</i>	47

TABLE OF CONTENTS

Relays for amp channel switching

Switch 1 / Switch 2

The Relay switching menu	48
Setting up	48

The Tuner

The Tuner in Play Mode	49
Tuner Mode parameters	50

Tap Tempo

Tap Tempo	50
-----------------	----

EFFECTS

Introduction	51
--------------------	----

Filter

Resonance Filter	52
Touch Resonance Filter	53
Auto Resonance Filter	53

Wah Wah	53
Touch Wah	54
Auto Wah	54

Formant Filters	55
Touch Formant Filters	55
Auto Formant Filters	55

Compressor

Compressor	56
Advanced mode	56
Sustaining & Percussive modes	57

Mod

Classic Chorus	58
Advanced Chorus	59

Classic Flanger	59
Advanced Flanger	60

Vibrato	61
---------------	----

Vintage Phaser	62
Smooth Phaser	62

Tremolo	63
Panner	64

Pitch Shifter	65
Octaver	66
Whammy	66
Detune	67
Intelligent Pitch-shifter	68

Delay

Single Delay	70
Tape	70
Reverse	70
Lo Fi	70
PingPong	70
Dynamic	71
Dual Delay	71

Reverbs

Reverb Types	72
Common Reverb Parameters	72

Parametric EQ	73
---------------------	----

Noise Gate	74
------------------	----

APPENDIX

MIDI implementation chart	75
Frequently asked Questions	76
Preset List	77
Technical Specifications	79

INTRODUCTION

Congratulations

At TC Electronic we are more than proud to present the new G-System that will be the center of your guitar setup in years to come. Presenting a new piece of equipment to guitarists is always exciting due to the very different demands they have. As you know, guitar gear is not comparable to “just a new keyboard with better sound” or “just a slightly better microphone”. Just think about it: Do you know anyone who has a guitar setup 100% identical to your own? Most likely not! Bearing that in mind, the task of building a piece of equipment like the G-System has been a tremendous challenge, well received by the entire dedicated staff at TC Electronic.

Utilizing the experience we have gained with its successful predecessors – the G-Force and the G-Major – and from the vast input and response we have received over the years from our customers, the G-System was born.

Features

- Floor-based Multi-effects processor.
- Up to 9 effects can be used simultaneously.
- Fast and smooth preset changes featuring Delay spill-overs.
- 4 switchable mono-loops for integration of your favorite effect pedals.
- 1 additional loop/insert point dedicated for pre-amps.
- 4 x 9V DC outlets powering your effect pedals.
- USB connector for software updates.
- Ultimate flexibility as the Control Board can be separated from the GFX01. This allows you to place the GFX01 with loops etc. in a 19" rack while leaving the Control Board on the floor.
- MIDI for control of additional external MIDI units.
- Connectors for 2/4 expression pedals.

Should this manual leave any of your questions unanswered, please use the TC Support service, which you can access via our website www.tcelectronic.com. Over a period of time, we will collect the most frequently asked questions and update the manual accordingly. Manual updates are available for download on our website in PDF format. The current manual revision number is found at the bottom of page 3.



INTRODUCTION

Once you are up and running what can you do?

How you get where you want to go is explained in later chapters in this manual – this section is only meant to serve as an inspiration while you are getting ready for building your dream setup.

The Five PRESET and BANK UP/DOWN Switches

Presets are organized in banks of five. Using the five PRESET switches together with the bank UP/DOWN switches allows you to make radical changes to your sound by pressing a single switch.

Presets Switches



Presets consist of:

- Effect Blocks (Reverb, Delay etc.) – both active and inactive ones.
- Settings for all Effect Blocks – for both active and inactive ones.
- Status (active/inactive) for all loops.
- The assignment of the connected expression pedals.
- Various other parameters.

The EFFECT BYPASS & LOOP Switches

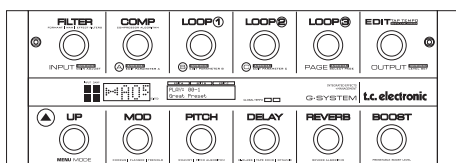

These switches allow you to turn effects (such as Delay, Reverb, Pitch, Modulation Filter, Compression and the Loops) on or off as parts of a presets. These switches are similar to the On/Off switches on regular stomp-boxes.

Three, four or five Loops

There are four loops – for drive pedals etc. – plus the Insert loop, which is especially designed to insert a pre-amp. For each preset you can decide which of the five loops should be active.

Additionally, you can switch loops 1 to 3 on and off using the Control board. If you also want to have access to the fourth loop via the board and maybe even to the Insert loop of a pre-amp (or a fifth pedal), you can set up your switches accordingly using the “Custom Switch Functions”.

What? How? Why?

You may find your own way of utilizing the system, but the following describes part of the philosophy that has been the basis of the G-System’s design.

For the purpose of the following example, let us assume that you have connected overdrive pedals to some or all of the four loops and maybe a pre-amp to the Insert loop. Expression pedals are excellent for either Volume control or real-time parameter control such as pitch in a “whammy” effect.

For the following example, your setup should resemble this one:

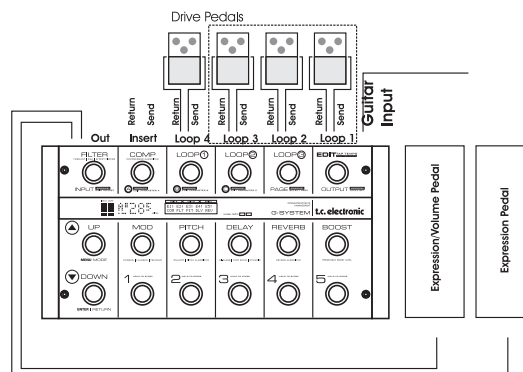

INTRODUCTION

- Use presets to organize your basic sounds. Presets are recalled using switches 1-5.

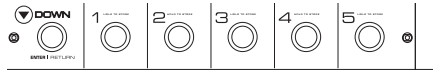

Example:

- 1 Rhythm 1
- 2 Rhythm 2
- 3 Crunch
- 4 Dist
- 5 Lead

Note that these names are just suggestions – this is not an actual set of presets. It is up to you how to benefit from the G-System's flexibility.

If you need more than five presets, simply press BANK UP and use another five. You have access to up to 40 banks with five presets each.

- Each G-System sound (preset) stores which loops and effect blocks are active and which parameters the expression pedals control.
- Presets hold all settings for all effect blocks – both the ones that are active in the preset and those that are not.
- Settings are stored both for active and inactive effects.

Once you have a basic set of presets such as the one above, you can switch between them in the different parts of a song using the preset switches. In addition, you can activate/ deactivate Effect Blocks *within presets* using the Effect On/Off switches. You can also activate/deactivate Loops 1 to 3 as desired.

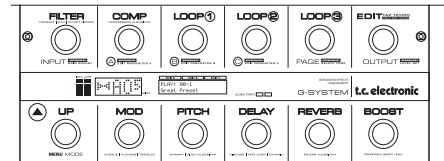

Example: You may start out your solo with a lead sound with a bit of Reverb, but as it evolves you may feel like adding some Delay, a Panner, an Octaver or maybe boosting the level using the BOOST switch.

Note that these are just ideas – it is up to you to explore the G-System's potential.

Custom Switch Functions

After some time, you may want to customize your setup.

For example, you may not be happy with the way the switches are positioned on the board.

You may want to access all five loops using the switches.

You may require eight preset switches, but you could e.g. live without bypass switches for FILTER, COMP and PITCH.

Go ahead! The G-System's board layout is a default suggestion based on input from numerous guitar players we have talked to.

You can customize this layout to your liking, making each switch do exactly what you want it to.*

To customize switch layout, press EDIT, press MENU and go to "Switches".

** Please note that the EDIT switch and the UP/DOWN switches can **not** be reassigned to other functions!*

QUICK SETUP GUIDE

This **Quick Setup Guide** will help you get started if you already have a basic idea of how you would like to use the G-System. If you are new to the world of multi-effect processors, you may feel that you need some more “in-depth” information. In that case, please refer to the relevant chapters of this manual. You may find the “Overview” section (pages 14 to 21) showing connectors, switches and encoders especially useful.

Unpacking

- Open the box. Be careful not to damage the items within the box with sharp objects, such as knives or scissors.
- Make sure that the package contains the following items:
 - G-System
 - Users Manual
 - Power cord
 - CAT5 cable
 - 4 x 50cm power cables for pedals
 - Labels for switches
 - Product registration card.
Register you G-System either by sending in the registration card or via www.tcelectronic.com.

Rackmount or Floormount?

Right out of the box, the entire G-System is assembled as one floormount unit. But check this out ...

The G-System consists of two main parts.

- 1) The **Control Board** – this is the board itself with the 1/4" stereo jack connectors for expression pedals and the RJ45 connector for the **GFX01**.

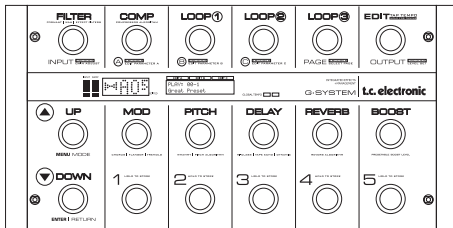

- 2) The **GFX01** – this is the 19" rack unit that contains the signal processing unit, connectors for loops, the power supply etc.



Per default, the two units are assembled as an “all-in-one” floor processor. However, if you wish to have all loop connectors to your pedals and e.g. a pre-amp neatly packed away in a 19" rack instead of spreading them all over the floor, you can easily detach the Control Board from the GFX01 and mount the GFX01 in your rack. For more details on the this procedure, please refer to the “Connections – Rackmount” section on the following pages.

Connections – Floormount

Now let us connect your G-System. We assume that you are using the G-System as one floormount unit – as it was assembled in the factory.

Let’s take a look at the rear panel of the GFX01.

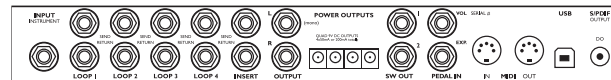

Input Instrument

- Connect your guitar to the socket labeled “Input Instrument”.

QUICK SETUP GUIDE



You must decide whether you use the Input on the front or on the rear of the GFX01. This is configured using the Input Select parameter in the Global (Glb) Levels menu.

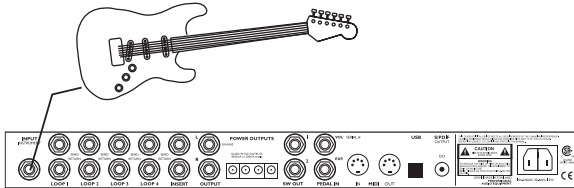

Loops 1 to 4 and Insert

- Connect up to four Overdrive/Distortion pedals – or other mono effects – to the G-System's four loops. Connect "Send" to the pedal's Input and connect the pedal's Output to "Return".

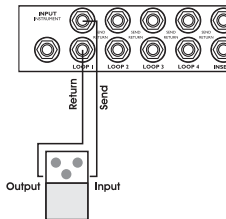

- If you also wish to connect a pre-amp, use the Insert loop. Connect the G-System's "Insert Send" to the pre-amp's input and connect the pre-amp's output to "Insert Return". Alternatively, a fifth stomp-box pedal can be used in the Insert loop.



- Be sure to activate all the pedals that you have connected in the loops.

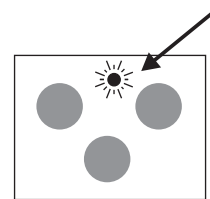

- If your pedals require a 9V DC power supply, the G-System provides 4 x 9V DC outlets (max 200mA combined), so you won't need an external power supply.

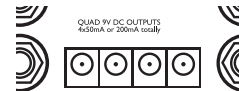

If you are in doubt as to which type of power your pedals require, you should consult the documentation that came with the pedal. On some pedals there is also a small label next to the power inlet, which you should check.

We are quite confident that once you have become familiar with the G-System, you will find that it is both easy to set up and customize. On the other hand, the flexibility the G-System offers means that it comes with a wealth of features that you may not want to utilize right away. You may also come across features that you didn't know you needed – until now!

QUICK SETUP GUIDE

Connections – Rackmount

As previously mentioned, the G-System can be separated into the Control Board and the 19" unit called GFX01. To detach the GFX01, simply unscrew the four rack mounting screws.

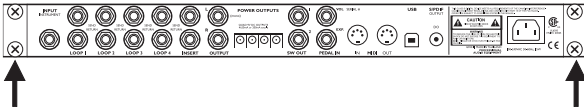

The GFX01's mounting screws are 6mm in diameter. However, some rackmount units require 5mm screws. Use appropriate screws!



To ensure maximum stability, a blank 19" faceplate must be mounted instead of the GFX01 after it has been removed from the Control Board.

- Connect pedals and pre-amps in the same way as described in the previous section for floormount operation.
- Once separated, connect the GFX01 and the Control Board using a long Cat 5 cable (not included).
- Connect the Guitar to "Input Instrument".



- To avoid having to run long cables from your expression pedals to your rack, the Control Board is equipped with duplicates of the two Expression Pedal connectors found on the GFX01.

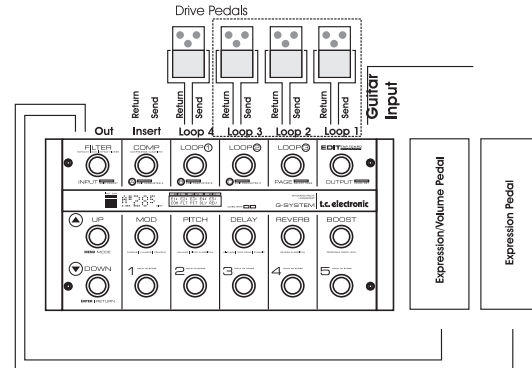

Levels

Set your drive pedals and the pre-amp to "reasonable" levels. Setting levels to maximum may cause internal overload, resulting in clicks and unwanted digital distortion.

When the red OVERLOAD LED on the INPUT meter lights up, the signal is too hot.

Not Good

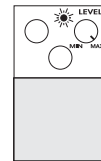

Good

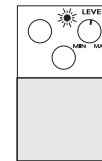

Overload LED



Depending on how the Input gain is set on the G-System, you may slightly have to adjust your drive settings on pedals and pre-amp when these are connected using the G-System loops.

QUICK SETUP GUIDE

Presets

- The G-System holds 100 Factory presets.
- You can store up to 200 User presets.
- Presets are organized in banks of five.

The 20 Factory banks are labeled: "A0" to "A9" and "B0" to "B9"

Each Factory bank holds five presets "1" to "5"

User banks are labeled: "0" to "39"

Each User bank can hold 5 presets "1" to "5"

Recalling (Loading) a Preset

- Recall a preset by pressing one of the PRESET switches (1-5). You select a preset bank using the UP and DOWN switches.
- Press both the UP and DOWN switch to quickly switch between the Factory and the User bank.



- It is up to you to which loops pedals should be connected (if at all). This is why no loops are active in the Factory presets.
- Loops 1 to 3 can be activated by simply pressing the LOOP 1 to 3 switches.

Editing Presets

To access effect parameters:

- Press EDIT. You are now in Edit Mode.
- Select which effect to edit using PAGE.
- When you have selected an effect to edit, press ENTER.
- Select a parameters page by pressing PAGE.
- Change parameter values using encoders A, B and C.

To switch effects on/off in Edit Mode:

- Press EDIT to enter Edit mode.
- Press PAGE to select an effect. Press ENTER.
- Turn PAGE clockwise to scroll through the parameter pages. At the bottom of the list you will find the "On/Off" parameter for the selected effect, which you set using encoder C.

Example

EDIT A	EDIT B	EDIT C
MIX 20%	OUTLEV 0dB	REVERB On

Effects that have a switch assigned to them can also be toggled on/off via the corresponding switch.



Loop 4, the Insert loop and effects that per default have no dedicated switches are accessed from Edit Mode.

Storing (Saving) Presets

To keep the changes you have made to a preset, the preset must be stored in the User bank.

- To enter Edit Mode (unless it is already active), press EDIT.
- Press and hold any of the five PRESET switches. You are now in Preset Handle mode and the Store function is selected per default.
- Select the desired storage location using encoder A.
- Now store the preset by pressing ENTER. If you want to change the name of the preset first, use encoders B and C.

QUICK SETUP GUIDE

Other Important Issues

The following is a list of other important issues you should take care of when setting up your system. Please refer to the relevant sections of this manual. Use the Table of Contents (page 3) for directions.

Read the Section “Setup Examples”

The “Setup Examples” sections gives a good overview of how the G-System can be connected to the rest of your gear.

Use correct cables for ...

- Loops 1 to 4
- the Insert loop
- Expression pedals

Calibrate your expression pedals

Expression pedals must be calibrated for best performance.

Make good use of the Boost feature

You can set a boost level in each preset and activate it using the BOOST switch.

Use the Locking functions to protect settings

- Lock the Insert loops if you have a pre-amp connected in that loop and wish to use the pre-amp in all presets.
- Lock the Boost level to have the exact same boost level in all presets.
- Lock the EQ section if you use the same EQ in all presets (i.e., as a “master EQ”).
- Lock Relays to keep the same relay settings regardless of how the relays are set in presets.
- Lock the Routing type if you only need to use one routing.

All Locking functions are located in the Utility menu.

Get the most out of your amp(s) using switch options

You can switch channels on your amp using the G-System’s four relays. Of course, these settings can also be stored as parts of presets.

Input Select

You must decide whether you want to use the Input on the front or on the rear of the GFX01. This is configured using the Input Select parameter in the Global (Glb) Levels menu. Press EDIT->MENU->turn PAGE.

G-SYSTEM MENU HIERARCHY

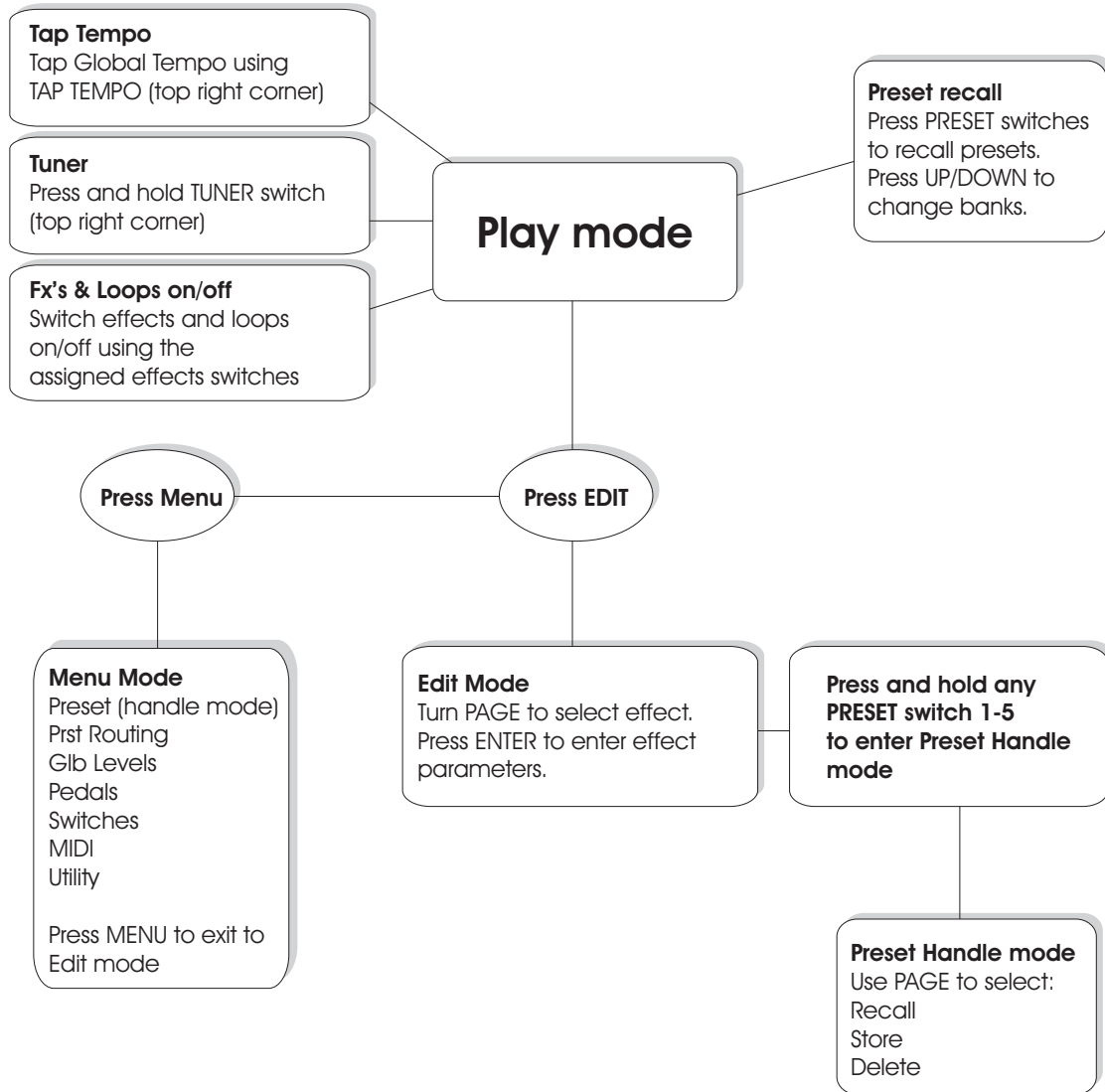

OVERVIEW

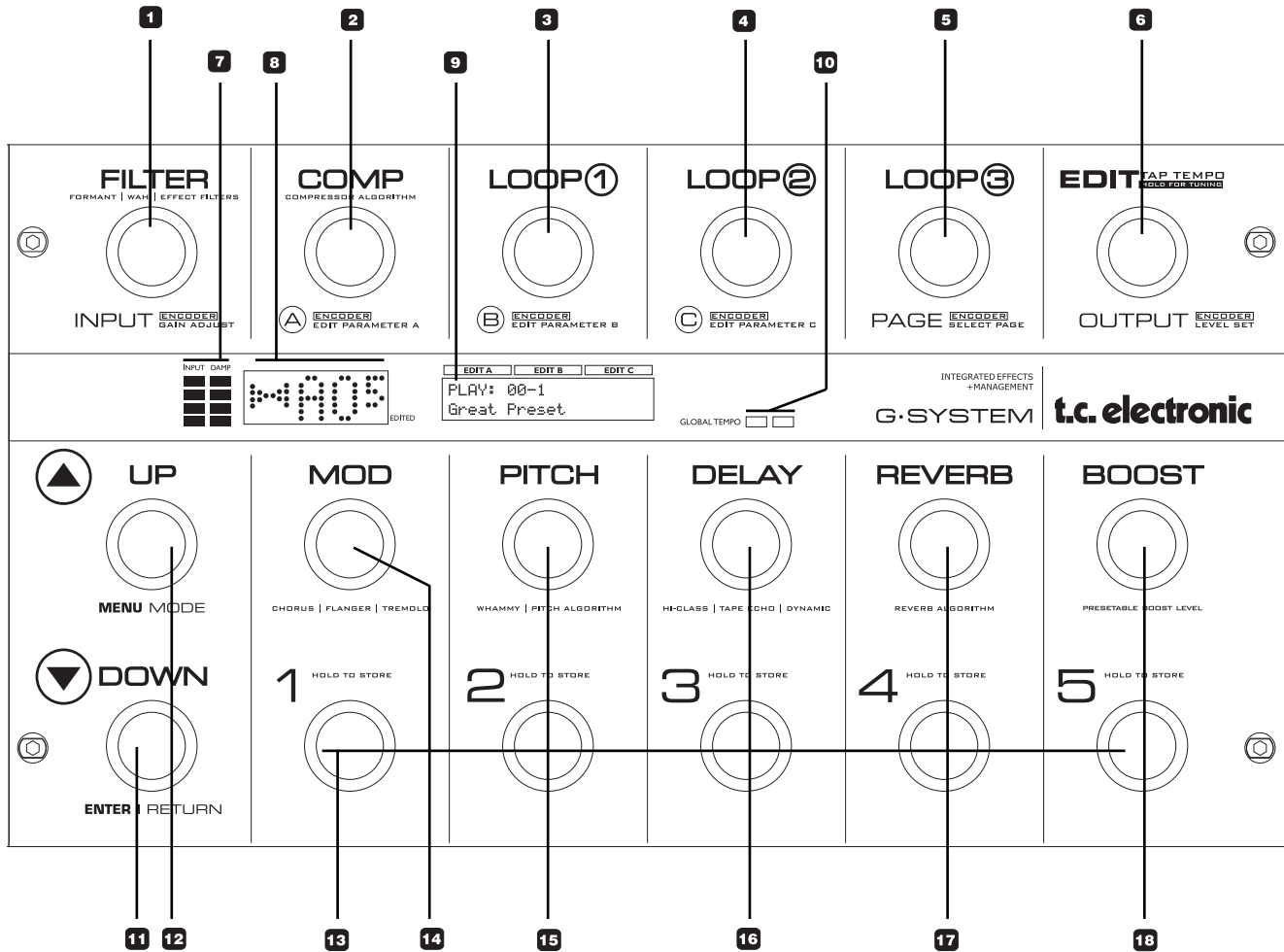

This section contains a brief description of the G-System's switches and their functionality in Play Mode and Edit Mode. To enter Edit Mode, simply press EDIT. These pages are meant as a general overview or quick reference. For more detailed information, please refer to the relevant chapters in this manual.

Naming conventions

Please note that most of the G-System's switches and encoders have more than one function and are labeled accordingly. So for example, we may refer to the first encoder either as FILTER or INPUT, depending on the context.

General Navigation – Basics

- The six top switches also act as *encoders*. They are used to change parameter values in the different *menus*. A menu is a group of related parameters.
- To access menus:
Press EDIT, turn PAGE, press ENTER *or*
Press EDIT and press EFFECT *or*
Press one of the LOOP switches and press ENTER
- Each page in the display has up to three parameters.
- The values of these parameters are adjusted using encoders A, B and C.
- Use PAGE to scroll through pages of parameters.

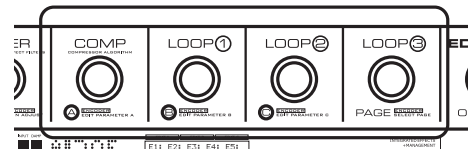

Play Mode

1 FILTER On/Off Switch

2 COMP On/Off switch

3 LOOP 1 On/Off switch

4 LOOP 2 On/Off switch

5 LOOP 3 On/Off switch

Edit Mode (Press EDIT to access)

Press to access the parameters for the effects in the Filter block.
Turn to adjust Input Gain.

Press to access the parameters for the Compressor.
Turn to adjust parameter A in the display.

Turn to adjust parameter B in the display.

Turn to adjust parameter C in the display.

Edit parameters are organized in groups of three per page.
Turn to select pages.

OVERVIEW

Play Mode

6 EDIT/TAP Tempo

Press to enter Edit Mode or *tap* to enter the global tempo. A given tempo can be subdivided to adapt it to a particular effect. The subdivision is set in the Effect Blocks using the Tempo parameter.

7 METERS

The meter on the left indicates the Input level. Set the Input level so that the red LED lights up occasionally. The meter on the right indicates Noise Gate and Compressor activity.

8 TUNER & PRESET NUMBER Display

The left side of the display indicates whether the incoming pitch is in tune. When both arrows are lit, the played note is in tune. In Tuner Mode, the tuner information can also be shown in the full display, e.g. combined with Output mute.

9 EDIT DISPLAY

Shows all editable parameters etc.

10 TEMPO LEDs

These two LEDs indicate the current Global tempo. This tempo can be tapped using the EDIT/TAP TEMPO switch. Use the Subdivision parameter to adapt the settings for each effect to this tempo.

11 DOWN – ENTER/RETURN

Use this switch to step down from one preset bank to the previous one (e.g. from bank 3 to bank 2).

12 UP – MENU MODE

Use this switch to step up from one preset bank to the next (e.g. from bank 2 to bank 3).

Edit Mode

Press to enter Edit Mode.

In Edit Mode, this encoder adjusts the Preset Output level.

In Edit Mode, use this switch to enter and exit various menus or to confirm important operations.

To enter Menu Mode, first *press* EDIT and then *press* the UP switch. In Menu Mode you can adjust various settings such as MIDI, Utility I/O and many more. For more detailed information, please refer to the relevant chapter in this manual.

Play Mode

Edit Mode

13 PRESET Switches 1 to 5

Press once to recall presets 1 to 5 in the current bank.

When you have made changes to presets (such as switching effects and loops on or off), you have to store them.

Press and hold for 2 seconds to enter Preset Handle Mode. In this mode, you can store presets, delete presets and edit preset names.

14 MOD On/Off Switch

Press to activate/deactivate the Modulation effects.

Press to access the parameters for the effects in the Modulation block.

15 PITCH On/Off Switch

Press to activate/deactivate the Pitch effects.

Press to access the parameters for the effects in the Pitch block.

16 DELAY On/Off Switch

Press to activate/deactivate the Delay effects.

Press to access the parameters for the Delay block.

17 REVERB On/Off Switch

Press to activate/deactivate the Reverb effects.

Press to access the parameters for the Reverb block.

18 BOOST On/Off Switch

Press to activate/deactivate the Boost function. On each preset you can set a boost level of up to 10dB. Press to activate/deactivate this function.

Press to go straight to the Boost level parameter. Note that the maximum boost level is set in the Levels menu.

OVERVIEW

Control Board – Rear

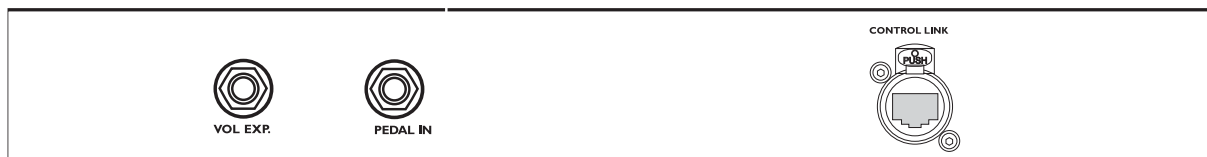

There are three connectors on the Control Board.

When the G-System is assembled, the Control Link connectors on the Control Board and on the GFX01 are connected with a short Cat 5 cable.

When the GFX01 is mounted in a rack, a longer Cat 5 cable (*not supplied*) is used. Use a high quality Cat 5 cable with XLR housing for maximum stability.

Expression pedals can be connected to either the GFX01 (when the unit is assembled) *or* to the Control Board when the GFX01 is mounted in a rack.

It is possible to connect two expression pedals to the Control Board and at the same time connect two expression pedals to the GFX01. This gives you two “handles” for each of the parameters assigned to these connectors, which you can place on stage where required.

For more information on expression pedals, please refer to the relevant sections of this manual.

GFX01 – Front

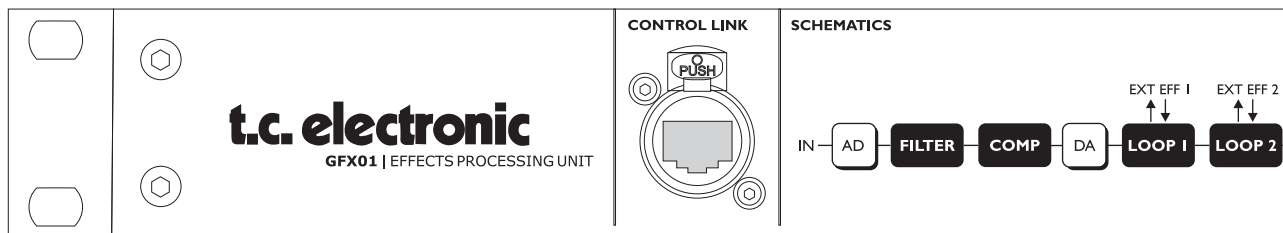

Control Link

Use a standard Cat 5 cable to connect the Control Board to the GFX01. A short cable is already mounted upon delivery when the G-System is assembled.

When you detach the GFX01 from the Control Board and mount it in a rack, use a Cat 5 of suitable length (max. 15 meters).

We suggest using a “road-proof”, high quality Cat 5 cable with XLR housing.

Mounting the G-System in a Pedal- Flightcase

Though the G-System is built from heavy-duty materials, you may wish to mount it in a flightcase for extra protection on the road. Therefore, the G-System's side panels have four screw threads (\varnothing 4mm).



Be sure to use the correct type of screws (M4) to avoid damaging the threads.

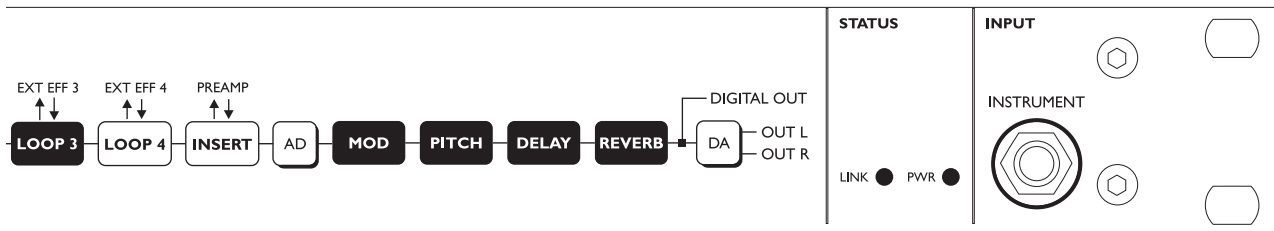
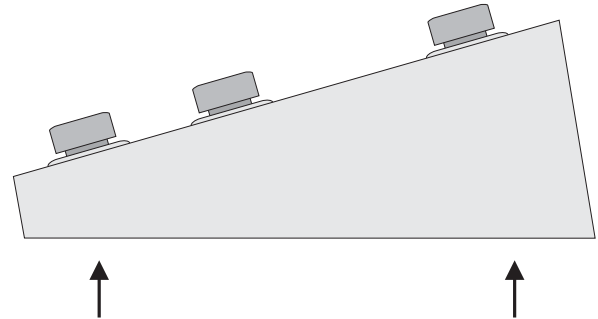

Instrument Input

The Instrument input on the front of the GFX01 is identical to the Instrument input on the rear. This is very convenient when the GFX01 is mounted in a rack and you wish to connect your guitar to the front.



You cannot connect guitars to both of these inputs at the same time. Which input to use is set up via the Input Select parameter located in the Global Levels menu. - See also page 35.

OVERVIEW

GFX01 – Rear

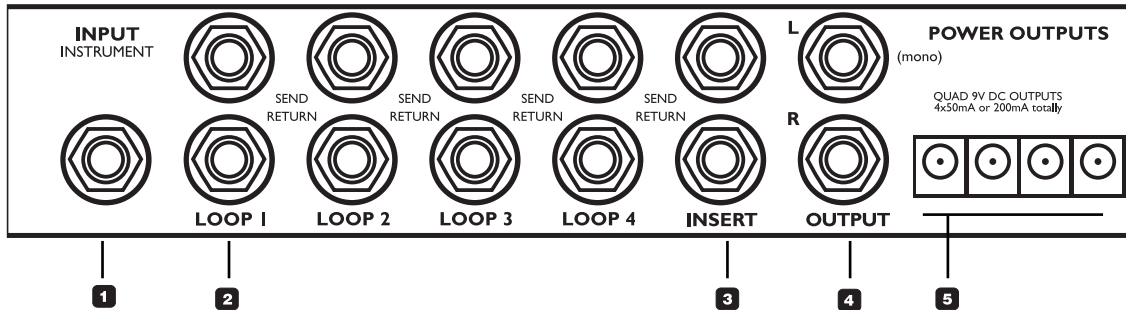

1 Input – Instrument

This is the input for your Guitar.

Note: If the G-System is separated and the GFX01 is mounted in a rack, you may use the identical Input on the front instead.

2 Loop 1 to 4

These loops are intended for connecting e.g. drive/distortion pedals. Use regular unbalanced jack/jack cables.

Connect a G-System's "Loop Send" to the input of the pedal and connect the output of the pedal to the same loop's Return connector.

All four loops are constantly sending. A loop only breaks when the 1/4" Return jack is connected. This allows you to split your lead signal, feeding multiple destinations, so you can e.g. use a Loop Send as a dry signal for a "3-way setup".

3

Insert

This loop is intended for a pre-amp. If cables longer than 3 feet are used, they should be balanced, *even if the connectors on the pre-amp are unbalanced*. When balanced cables are used, a special pseudo balanced circuit will

reduce the noise which would occur when using unbalanced cables.

4 Output

Left/Right output to your amp or amps.

5 Power Outputs

4 x 9 Volt DC to power connected pedals. Maximum combined load on these outlets is 200mA. Please check the specifications on connected pedals: Ring (+), Pin (-).

6 SW Out (Switch Out)

The two 1/4" stereo jack switch connectors can be used to switch channels e.g. on a pre-amp or a combo amp either at preset change or when sending a CC change.

Switching options are:

- Tip to Ground
- Ring to Ground
- Tip and Ring to Ground
- No Connection

for each of the two connectors.

Depending on the channel switching facilities on your pre-amp, different cables should be used.

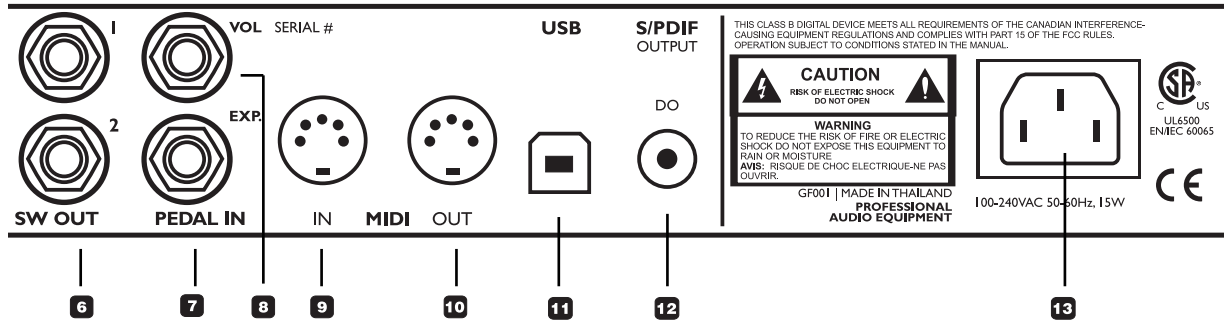

Schematics for *some* amps are available at www.tcelectronic.com. If you cannot find your amp type there, please contact the manufacturer of your amp.

7 Pedal In – Exp. (Expression)

Connector for an expression pedal to control e.g. pitch in a whammy effect.

8 Pedal In – Vol (Volume)

Connector for an expression pedal. A connected expression pedal will per default control the Input Gain parameter.

9 MIDI IN

On the MIDI IN port, the G-System can receive MIDI information such as MIDI Program Change messages (for preset changes) and Continuous Controllers (MIDI CCs). You can use these to remote-control G-System parameters.

10 MIDI OUT

The G-System sends out MIDI Program Change messages when a preset is recalled.

11 USB

Use the USB port to update the G-System's software from a computer.

12 S/PDIF – Digital Out

Digital output, e.g. for feeding a digital audio recorder.

13 Power Input

The G-System's switch mode power-supply accepts from 100 to 240 Volts AC.

TYPICAL SETUP

If you an experienced gear “nerd” already, this page will not apply to you. This page gives information on a few basic issues regarding amp types.

Generally said - all setups include both a pre-amp and a power-amp. This applies whether it is a Head, a Combo or a split system with separate pre/power-amp. How to enter and exit these components is a different story. However, “Send” is usually equal to “Pre-amp out” and “Return” is usually equal to “Power-amp in”.

Pre-amp

The pre-amp generates your basic tone. It usually has 2 or more channels. E.g:

Channel 1 Clean
Channel 2 Lead

The Pre-amp could also be viewed as an advanced overdrive or distortion pedal.

Power-amp

The power-amps main object is to amplify the sound generated by the pre-amp and effects that are placed in front.

Head

A “head” is a pre-amp and a power amp built into one box. It is as simple as that.

The Input on the front is the pre-amp input.

The effect loop Send – is the pre-amps output.

The effects loop Return – is the Input of the power-amp.

Combo

The Combo amp is identical to the Head but also has built in speakers – hence the “combo” or “combination” expression.



We are quite aware that not all amps are built and labeled exactly alike and the generic explanations above must therefore be considered as a basic guide. We also recognize the importance and tone-differences of the power-amp models, tube-types etc. - This page is a reference for basic understanding of the principles of guitar amplification only.

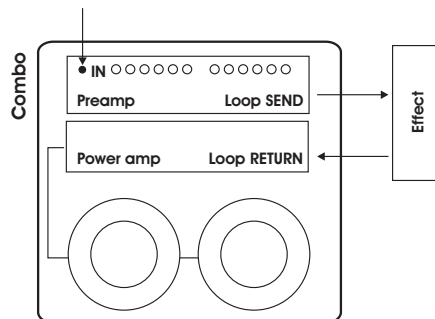
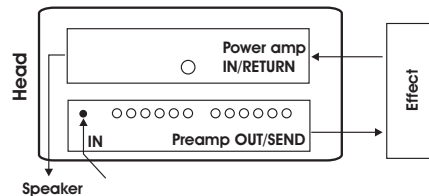
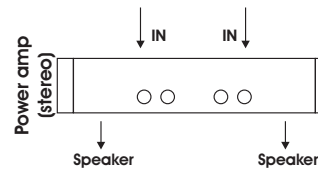
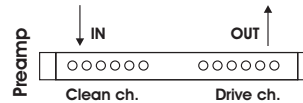

TYPICAL SETUPS

In this section we will take a look at some examples of how the G-System can be connected to your gear. There are probably no two setups that are 100% identical. We suggest you look for the setup that comes closest to your own.

Pedals and Amp

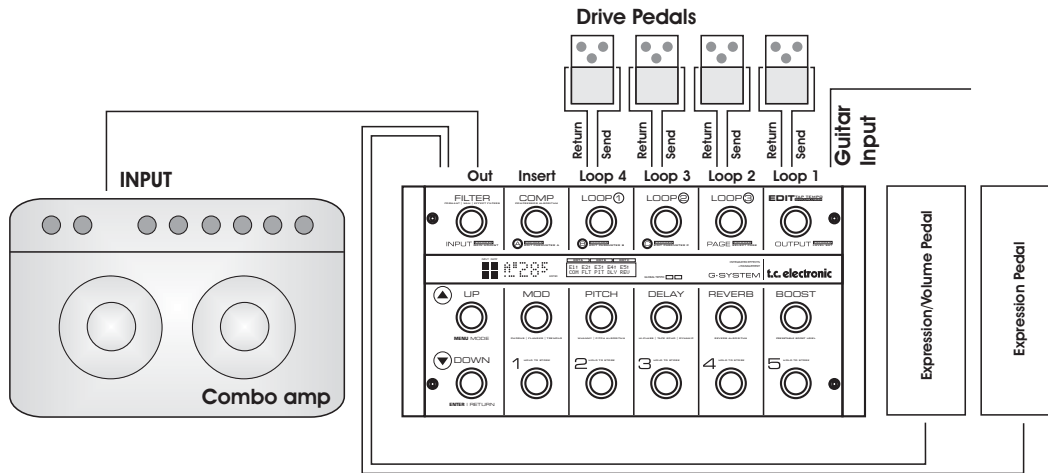

In this setup, we are using up to four drive pedals and a single combo amp. If you add another amp, you have a stereo setup.

The two expression pedals are optional. If connected, you can use them to control e.g. a volume parameter or a pitch for “whammy”.

Connecting

- Connect your guitar to the Instrument Input.
- Connect up to four drive pedals to the loops.
- **All pedals connected to the loops must remain switched on at all times.** The G-System activates/deactivates the loops – not the pedals!
- Connect expression pedals using a single standard 1/4" jack cable. Depending on the expression pedal model, the cable must be mono or stereo.
- Connect the G-System's Out to your amp's input or to the amp's effect loop return. Use two amps for stereo operation.
- Connect expression pedals and calibrate these using the Pedals menu.

TYPICAL SETUPS

Pedals, pre-amp and Amp

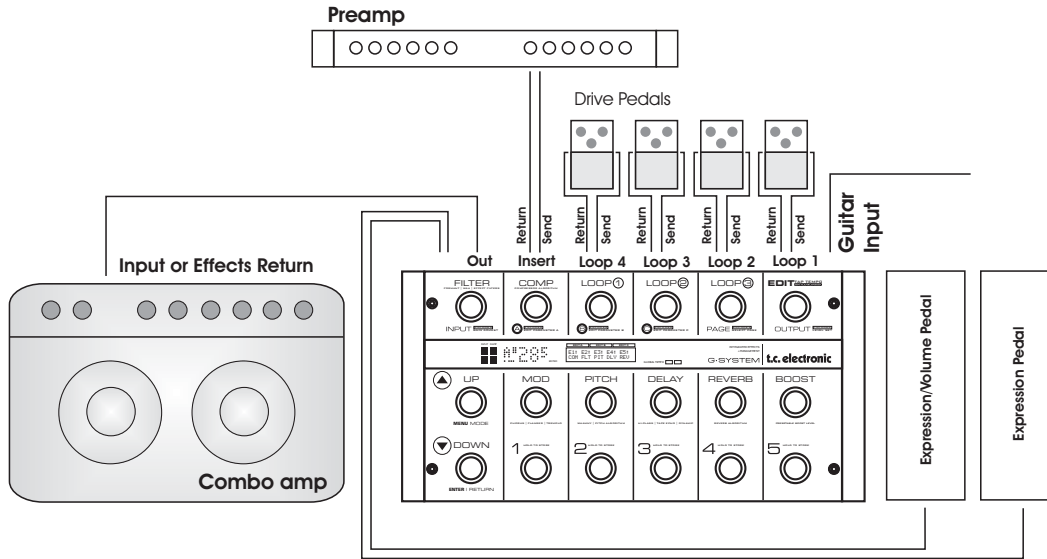

This setup is similar to the one described in the first example, but we have now added a pre-amp to the Insert loop. You can decide to have the pre-amp in or out of the signal chain per preset, but you will probably prefer to have it “on” at all times. This is configured in the Utility menu, which you can access in Menu Mode.

With a pre-amp in the signal chain, you can choose to connect the G-System to the input or the effects return (“power-amp in”) on the combo amp.

Using the regular input on the combo amp gives you a “double-pre-amp” setup where you can use the tone controls on the combo to color your sound. This has become a popular setup with amplifiers like the Vox AC 30, Fender Bassman etc., but using it introduces more noise than using the effects loop return connector.

Connecting

- Connect your guitar to the Instrument Input.
- Connect up to four drive pedals to the loops.
- **All pedals connected to the loops must remain switched on at all times.** The G-System activates/deactivates the loops – not the pedals!
- Connect expression pedals using a single standard 1/4" jack cable. Depending on the expression pedal model, the cable must be mono or stereo.
- Connect a pre-amp to the Insert loop. **Set the Insert loop to “on” in the Loop menu.** If you are using a MIDI pre-amp, you must also connect the G-System’s MIDI Out to your pre-amp’s MIDI In using a standard MIDI cable.
- Connect the G-System’s Out to your amp’s input or to the effect loop return. Use two amps for stereo operation.
- Connect expression pedals and calibrate these using the Pedals menu.

Pedals and Head

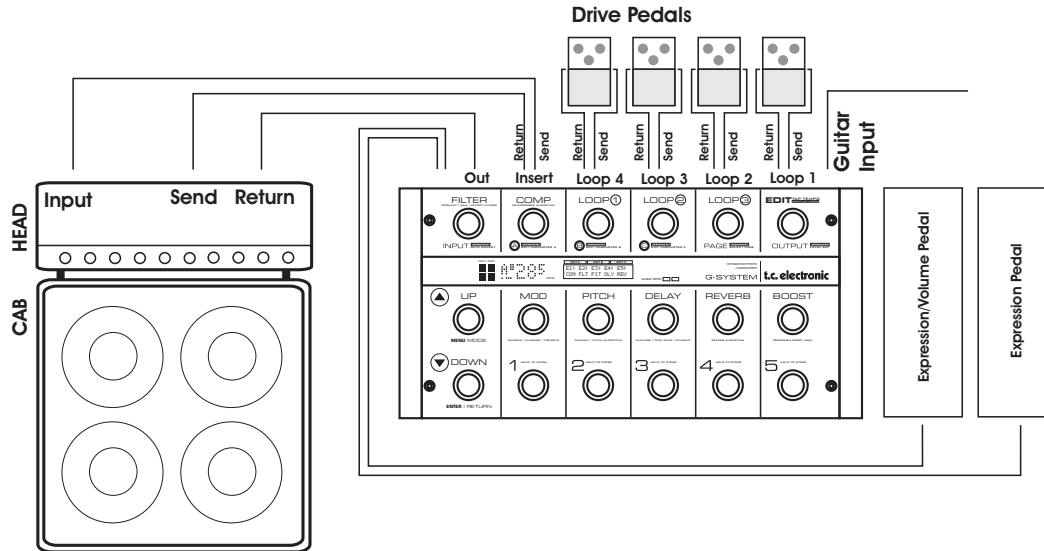

In this setup we are using a head as both pre-amp and power amp. The pre-amp section of the head is connected to the G-System's Insert loop. Set the Insert loop to "on" on all G-System presets, using the Utility menu.

Look at the illustration and see if you can follow the signal chain:

- Connect your guitar to the G-System's Input.
- Up to four pedals can be connected in loops 1 to 4.
- Via the Insert loop's "Send", the signal is sent to the head's input.
- The head's pre-amp out/send goes to the G-System's Insert loop "Return". This way, the entire signal from the drive pedals and the pre-amp section of the head is returned to the input of the G-System's effects section.
- Via the G-System's Out Connector, the signal is sent to the head's return – which is actually the input of the head's power-amp section.

Connecting

- Connect your guitar to the G-System's Instrument Input.
- Connect up to four drive pedals to the loops.
- **All pedals connected to the loops must remain switched on at all times.** The G-System activates/deactivates the loops – not the pedals!
- Connect expression pedals using a single standard 1/4" jack cable. Depending on the expression pedal model, the cable must be mono or stereo.
- Connect the G-System's "Insert Send" to the head's input. Connect the head's effect loop send to the G-System's "Insert return".
- Connect the G-System's "Out" to your amp's effect loop return ("power-amp in"). Use two amps for stereo operation.
- Connect expression pedals and calibrate these using the Pedals menu.

TYPICAL SETUPS

Three-way: Split to Multiple Amps

In this particular setup, the center amp is receiving the dry signal only – i.e., with no effects apart from those added via the active pedals in Loops 1 to 4. The left and right amplifiers receive *only* the effects. On all G-System presets, “Mix” must be set to 100%. In this particular setup, the mix of the effects is set solely using each effect’s Out level parameter.

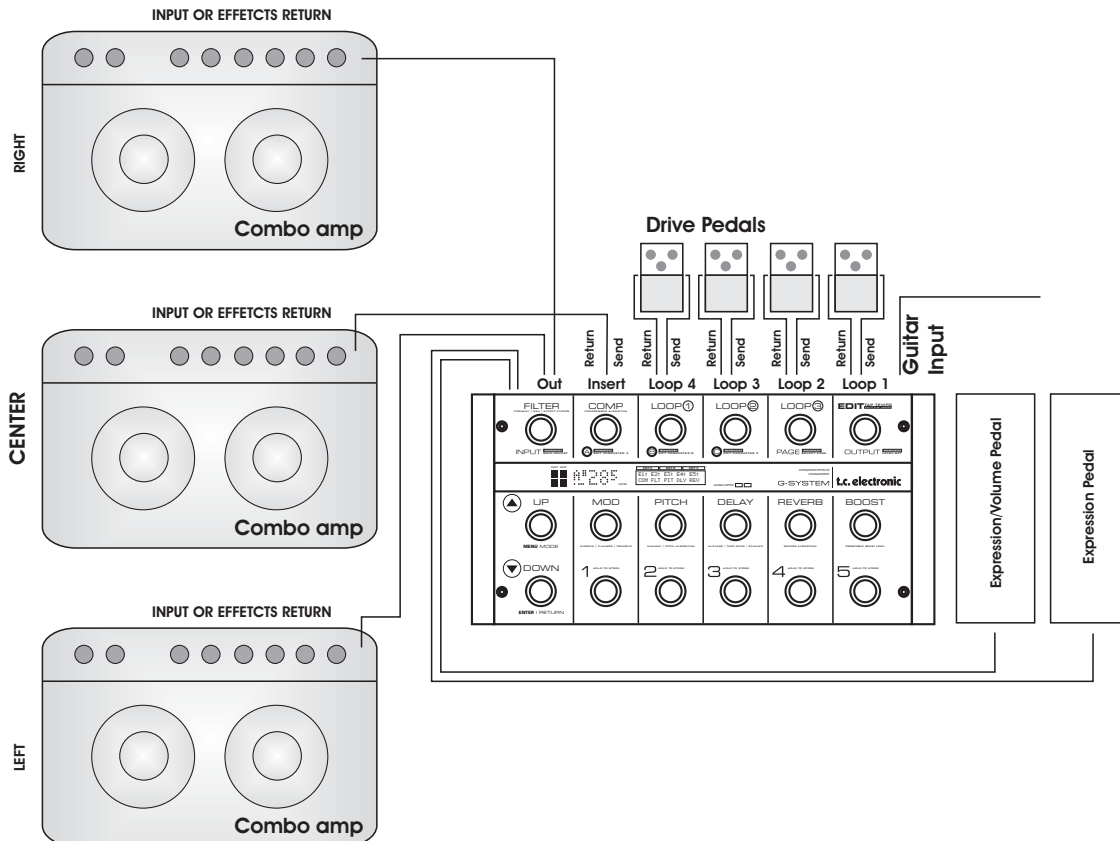

Dual amp

From Software version 1.05 it is possible, on each preset to decide how much signal should be sent on left and right output. This is setup in the Preset Routing menu located at: EDIT->MENU->Prst Routing
With this option you can e.g:

- Send all clean sounds to the amp connected to left output.
- Send all drive sounds to the amp connected to right output.
- Use both connected amps on some presets and even have control of the output level sent to each amp.

In the setup illustrated below the pre-amp section of one amp is connected to Loop 4 and the pre-amp of the other amp to the Insert-loop.

This means that you are able to select which pre-amp-section (or both) you would like to use for each preset.

Most often you would NOT use both pre-amps at the same time.

A similar common application could be using the G-System with a just few drive pedals and two different amps of your choice. E.g. one for drive sounds and one for clean sounds. On Each preset you decide which amp to send the signal to.

Compared to the illustration below that would mean no cables to the amps Send/Return connections.

For advice on how to connect the drive and expression pedals, please refer to the descriptions on the previous pages.

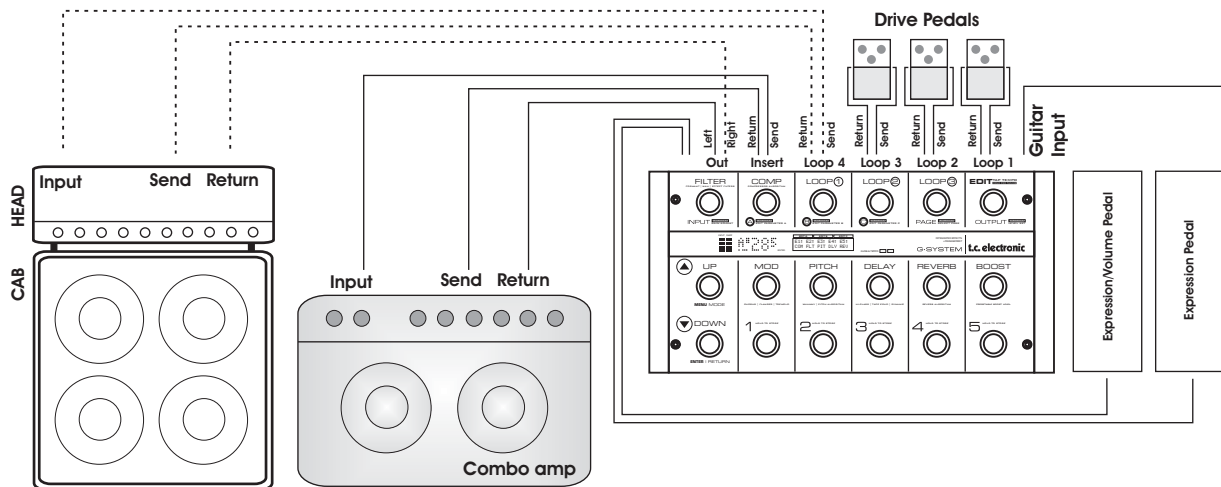

TYPICAL SETUPS

G-System Separated: GFX01 in a Rack

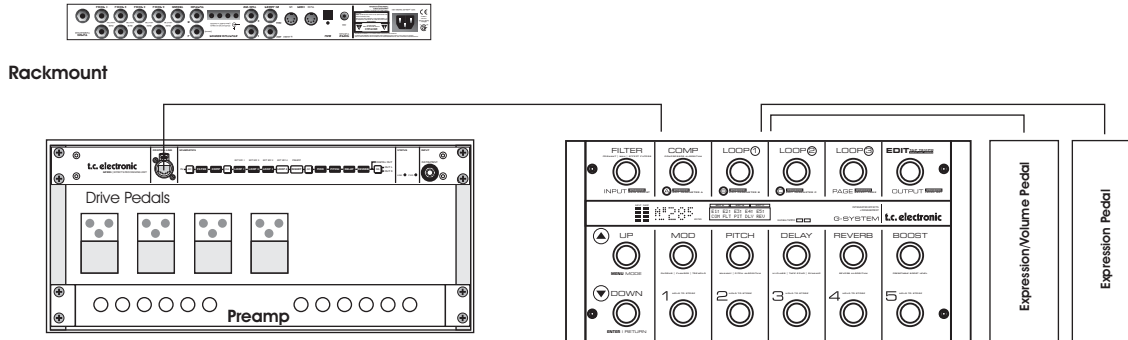

Connections

- Unmount the GFX01 (the 19" unit) from underneath the Control Board by unscrewing the four 6mm screws.
- Replace the short CAT 5 cable with a longer cable.
- Mount the 19" GFX01 in your rack.



Please note that some racks require 5mm screws, while others require 6mm screws. The G-System is assembled using 6mm screws. Use appropriate screws for your rack.

For advice on how to connect the drive and expression pedals, please refer to the descriptions on the previous pages.

Important!

When the GFX01 is separated from the Control Board, we strongly recommend mounting a 1 unit standard blank faceplate instead to ensure maximum stability.



If you do *not* use a Cat 5 plug with angled XLR housing, you can turn the wings that are holding the blank faceplate by 180 degrees to make space for a normal XLR plug.

This is easily done:

- Unscrew the two screws in each side-panel.
- Turn the wings by 180 degrees.
- Mount the wings again using the screws.

ADDITIONAL SETUP INFORMATION

Other Important Issues Regarding Setups

The following is a list of other important issues you should take care of when setting up your system. Please refer to the relevant sections of this manual. Use the Table of Contents (page 3) for directions.

Use correct cables for ...

- Loops 1 to 4
(Quality mono jack/jack cables)
- the Insert loop
(Quality jack/jack cables – use balanced cables if they are longer than 1 meter)
- Expression pedals
(Mono or stereo, - depending on the type of expression pedal used).

Calibrate your expression pedals

Expression pedals must be calibrated for best performance.

Use the Locking functions to protect settings

- *Lock the Routing type* if you only need to use one routing.
- *Lock the Insert loops* if you have a pre-amp connected in that loop and wish to use the pre-amp in all presets.
- *Lock the EQ section* if you use the same EQ in all presets (i.e., as a “master EQ”).
- *Lock the Boost level* to have the exact same boost level in all presets.
- *Lock Relays* to keep same Relay positions on all presets.

All Locking functions are located in the Utility menu.

Make good use of the Boost feature

You can set a boost level as part of each preset and activate it using the BOOST switch. Per default, the boost is set to +6dB on all factory presets, but you can boost to as much as 10dB. You will enjoy this feature

whenever you just want a little extra power for certain phrases and don't want to create a new preset with a different level.

Notice that the “Boost Max” parameter found in the Levels menu limits the available amount of boost.

Get the most out of your amp(s) using switch options

You can switch channels on your amp/pre-amp using the four relays on the two stereo jack connectors on the G-System.

To set up Relay switching, press EDIT, turn PAGE to select RELAYS and press ENTER.

Read the section on Relays for detailed information.

Input Select parameter

The GFX01 has two Instrument inputs: one on the front and one on the rear. You have to tell the G-System to which connector you have connected your guitar.

This is set up using the Input Select parameter, which is located in the Global Levels menu. The options are “Front” and “Rear”.

PLAY MODE & EDIT MODE

Introduction

Play Mode is the mode you will use while playing. In Play Mode you can recall presets, switch Effect Blocks on or off and control parameters using expression pedals.

When you are in Play Mode, the top of the display reads “PLAY”.

Example:

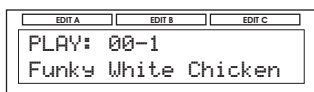

What is a preset?

Use Presets to store and recall your favorite sounds by pressing a single switch.

A preset holds the following information:

- Effect Blocks (Reverb, Delay etc.) – both active and inactive ones.
- Settings for all Effect Blocks – for both active and inactive ones.
- Status (active/inactive) for all loops.
- The assignment of the connected expression pedals.
- Various other parameters.

Factory Presets/User presets

Per default, the G-System holds 100 Factory presets. In addition, you can store 200 presets in the User area.

Factory presets are organized in:

Banks A0 to A9 – with five presets each.

User presets are organized in:

Banks 0 to 39 – with five presets each.

Use the UP and DOWN switches to select Preset banks. Use the PRESET switches 1 to 5 to recall the Presets in the current bank.

Factory Presets

The factory presets show many combinations of effects and you will probably find many of them to be excellent starting points for your own presets.

In all factory presets, both the four effect loops and the Insert loop are deactivated.

This means that although you may wish to use a factory preset as a starting point, you will have to activate the loops for each preset and store them in the user bank to use the pedals and pre-amp connected to the loops.

After having worked with the G-System for a while, you will therefore most likely find yourself working in the User bank all of the time and only using the Factory bank as an inspiration for new ideas and sounds.

User Presets

You can store up to 200 User presets with your own choice of effects, active loops, amp channel switching etc.

Example: Recalling a preset

- Use the UP/DOWN switches to select the desired bank. The bank and preset number will blink, indicating that the preset has not yet been recalled.
- Hit the PRESET switch (1 to 5) corresponding to the preset you wish to recall.

The Bank and Preset number will now stop blinking, indicating that the preset has been recalled.

The parameters found in the Utility menu are not stored or recalled as part of presets.

It is possible to lock the settings of EQ, Insert loop and Boost. To access the Locking functions, press EDIT, press MENU and select Utility.

Locked parameters will not be recalled, either.

PLAY MODE & EDIT MODE

Editing

Editing G-System presets is quite simple.

Editing Presets in Play Mode

- Activate/deactivate loops and effects simply by pressing the corresponding switches. When a switch is lit, the corresponding function is active.

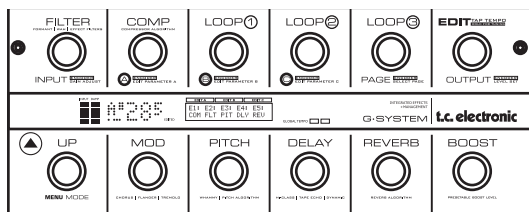

Effects with no dedicated switch, Loop 4 and the Insert loop are activated/deactivated in Edit Mode.

Editing Presets in Effects Edit Mode

In this mode, you set up the various effect parameters.

- Press EDIT.
- Select which effect to edit by turning PAGE and pressing ENTER.
- Parameters are organized in pages of three. Select a parameter page using PAGE.
- Edit the shown parameters using encoders A, B and C.

Example

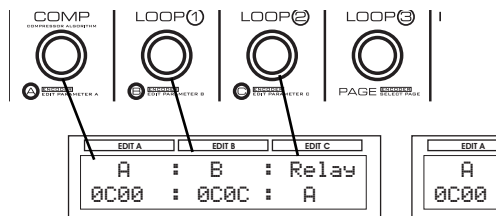

Fast Access to Effect Parameters

If the effect you wish to access has a switch assigned to it, the parameters are easily accessed simply by pressing EDIT, followed by the assigned switch.

Example: Press EDIT and then REVERB to access reverb parameters.

Selecting Effect Types

Each effect block includes several different subtypes of effects. As an example the Delay block includes: Single Delay, Tape Delay, Reverse, Lo-Fi, Pingpong, Dynamic and Dual Delay.

Selecting the Effect type is part of the Effects Edit mode.

- Press EDIT to enter Edit mode.
- Select effect block using the PAGE encoder and press ENTER.
- Turn the PAGE encoder one click counter-clockwise.
- Select the wanted effect type using encoder C.
- Press ENTER.

Loops Status

- Press EDIT and any of the three LOOP switches.
- Use PAGE to select the Loop page.
- Set loops on or off using encoders A, B and C.

PRESET HANDLE MODE – STORE / DELETE

Overview

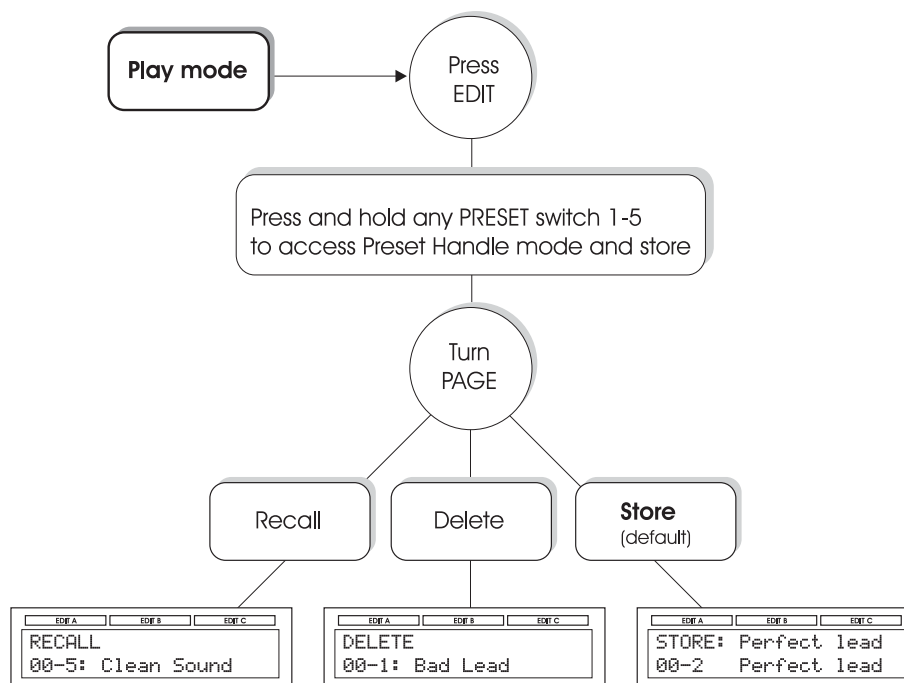

Preset Handle Mode

In Preset Handle Mode, you can store, recall, delete and rename presets.

Entering Preset Handle Mode

- Press EDIT.
- Press and hold any of the PRESET switches 1 to 5.
- Select a function from the Store, Recall and Delete range using the PAGE encoder.

Please note that presets can easily be renamed in Store Mode.

Store

- You can store up to 200 presets in the User bank.
- When storing a Factory preset:
The G-System suggests the first free slot/location.
- When storing a User preset:
The location corresponding to the pressed switch is suggested, but you can select *any* location in the User bank using encoder A.

OVERVIEW – PRESET HANDLING

How to Store a Preset – Step by Step

- Press EDIT to enter Edit Mode.
The display will read something similar to:

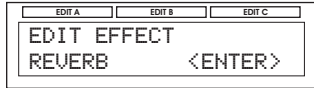

- Press and hold any PRESET switch (1 to 5) for two seconds.



You are now in “Preset Handle Mode”, and the Store function is selected per default. You can, however, select between Store, Recall and Delete submodes by turning the PAGE encoder.

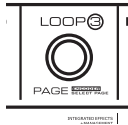

- If the preset you are trying to store is a Factory preset, the first free store location in the user bank is suggested.

If the preset you are trying to store is a User preset, the location corresponding to the current bank and pressed switch is suggested.

In both situations, any location can be selected using encoders A, B or C.

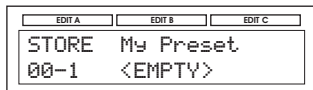

In the example above, Location 1 in Bank 00 has been selected.

- Now either confirm the storage location by pressing ENTER or edit the preset name by using encoders B and C. Use Encoder B to select character position and Encoder C to select characters.

Deleting a Preset

You may wish to “clean up” the user bank by deleting some presets.

- Select Delete Mode using the PAGE Encoder.
- Select a preset to be deleted using Encoder A and press ENTER. Confirm on demand.

Copying Effects Between Presets

The Copy function allows you to copy e.g. your favorite delay or reverb settings to another preset without having to dial in the same parameters twice.

- First recall the preset you wish to copy an effect to.
- Press EDIT and select the effect whose settings you want to override with settings from another preset by using PAGE and ENTER.
- Select “COPY >EFFECT< FROM” by turning PAGE counter-clockwise.
- Now select the preset from which you want to copy effect settings using encoder C.
- Press ENTER.

For example, if you are copying Reverb settings, the display will read:

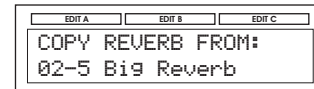

- Press ENTER.
- Store the modified preset if you want to.

MENU MODE – OVERVIEW

To access Menu Mode:

- Press EDIT
- Press MENU.

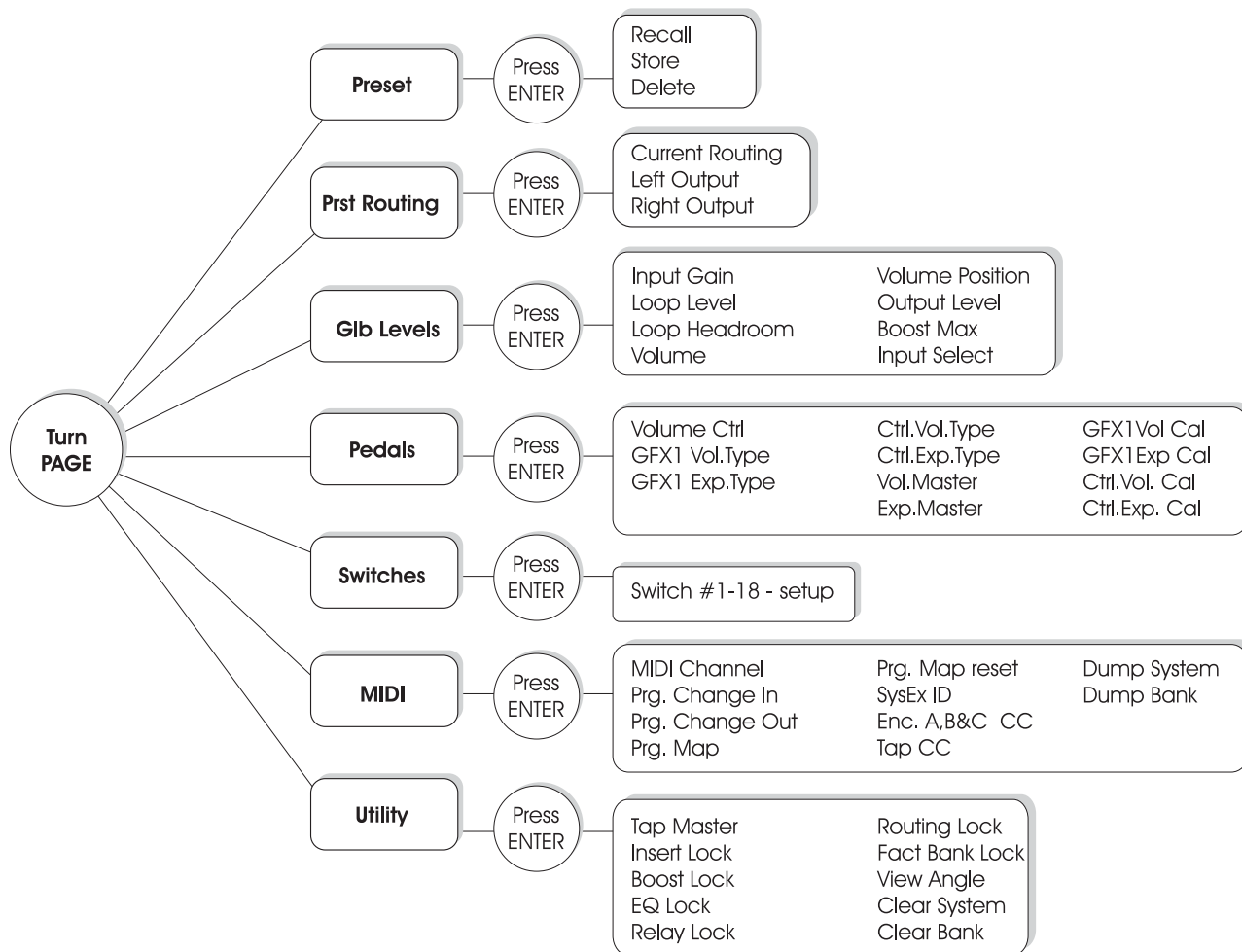

MENU MODE – PRESET ROUTING

Effect Routings:

What are they and what are they used for?

The available routings for Effects are:
Serial, Semi-parallel or Parallel.

Take a look at the illustrations below and read the explanations to understand the differences.

Setting Routings

- Press EDIT and MENU and turn the PAGE encoder to select the PRST* Routing menu.
- Press ENTER and select the desired routing by turning Encoder C.
- Press ENTER to confirm the selected routing.

The selected routing can be stored as part of an individual preset, or it can be locked for all presets by setting Routing Lock to “On”.

*PRST - Preset

Serial Routing

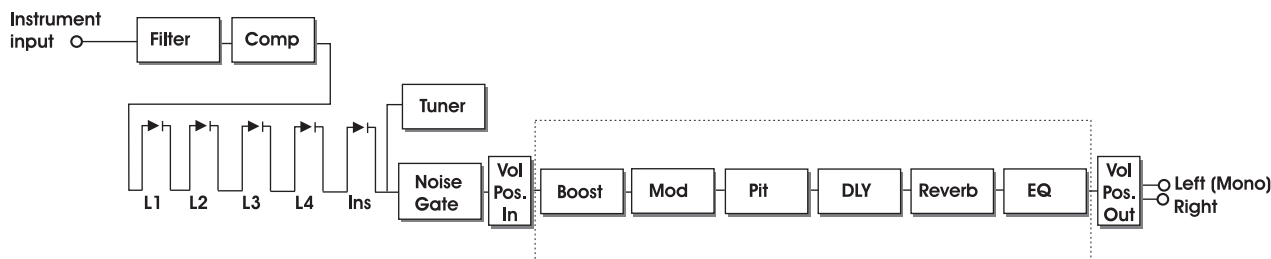

The Serial routing connects all Effect Blocks “in a straight line”, similar to a regular guitar stomp box setup. This means that each Effect Blocks affects the following effect(s).



If a delay with a long delay time is used in combination with a reverb, you may find the added Reverb on the Delay repeats disturbing. In that case, use either the Semi Parallel or Parallel routing.

MENU MODE – PRESET ROUTING

Semi Parallel Routing

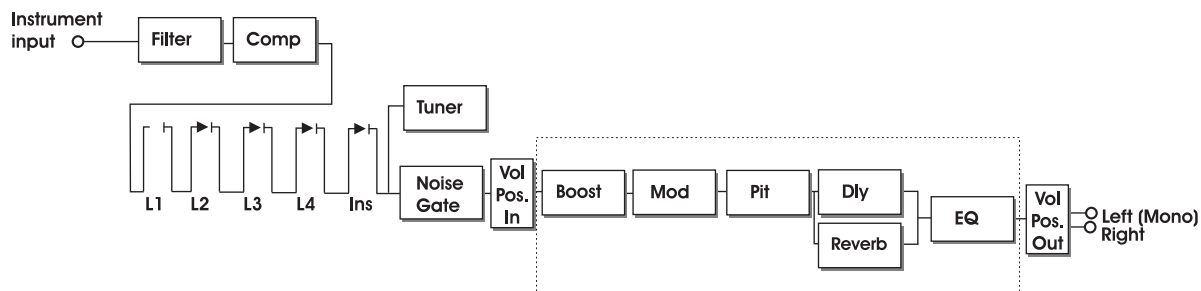

The Semi Parallel routing connects most Effect Blocks serially, but the Reverb and Delay blocks are now connected in parallel. Consequently, the Delay and Reverb effects do not affect each other. This means that e.g. the repeats of the Delay are not reverberated.

The parallel connection of the Reverb and Delay may help to “clear the effects picture” when using both Delay and Reverb.

Parallel Routing

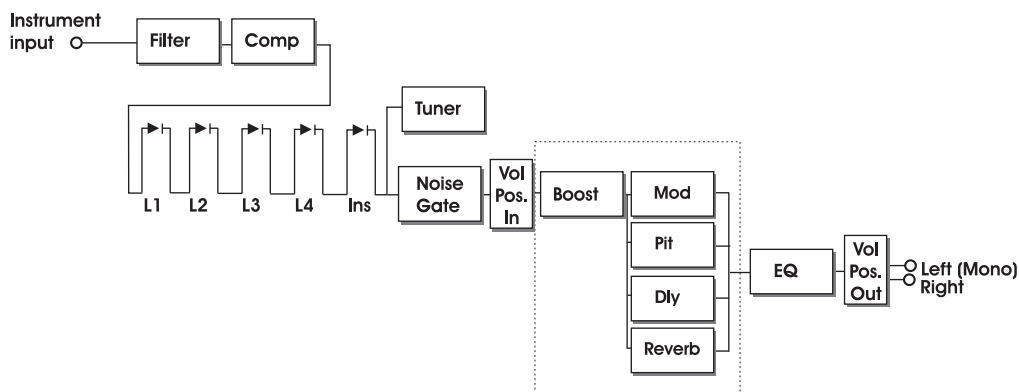

In the Parallel routing, the same signal is fed to the input of the Modulation, Pitch, Delay and Reverb sections, and therefore these effects will not affect each other.

MENU MODE – PRESET ROUTING & GLOBAL LEVELS

Left/Right Output levels

In the Preset Routing menu it is also possible to store individual levels for Left and Right Outputs. The range is -100 to 0dB.

These parameters allow you to e.g. use two different amps for a dual mono setup and decide for each preset which amp to send to. You can even send to both and at levels of your own choice.

Routing Lock

For each preset, you can choose which of the three routings you want to use. But if there are no specific benefits gained from changing between routings (mostly there aren't), we suggest that you use the Routing Lock function.

With the Routing Lock function activated, you will not have to worry about selecting a routing for each preset. In addition, you will benefit from the smoothest preset changes possible.

Many guitarists choose the Serial routing and stick with it.

Setting Routing Lock

- Press EDIT, then MENU and turn the PAGE Encoder to select the Utility menu.
- Press ENTER and select Routing Lock by turning the PAGE encoder.
- Set to “On” or “Off”.
- Exit by pressing EDIT.

Optimizing the Noise Level

Here is some advice on how to reduce noise and how to get the best signal-to-noise ratio with the G-System.

Cables

First of all: **Good cables are essential!** We advice that you use properly shielded cables throughout your entire system, but remember that the quality of the cable connecting a guitar with passive pickups (e.g. a Strat type) to the G-System input is a very sensitive point in the signal chain. The few extra bucks for good cables are well spent.

Avoid max. levels on connected Pedals and pre-amp.

The loops have a great dynamic range and will accept most pedals on the market. However, it *is* possible to hit the loop returns too “hot”. Max levels on pedals in loops may cause internal overload in the G-System, resulting in digital clipping. Therefore, you should work with reasonable levels on the connected loops.

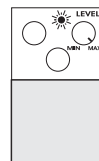

Not good

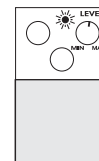

Good !

The Insert Loop

If you chose to have a pre-amp in the Insert loop *and place the pre-amp far away from the G-System** we HIGHLY recommend using balanced cables. This also applies if your pre-amp has no balanced connectors (most haven't).

When you use balanced cables to connect a pre-amp to the Insert loop, a special pseudo-balanced circuit will reduce the noise otherwise introduced.

* More than a meter

Input Level

The G-System's Instrument input is per default adjusted to match most guitar pick-up levels. However, you can

MENU MODE – GLOBAL LEVELS

fine-tune the Input sensitivity to achieve best performance and best signal-to-noise ratio.

- Press EDIT and use the INPUT Encoder (first Encoder in the top row).
- Also set the Boost Max. and Loop Headroom parameters.

All level parameters in this menu are global and not stored as a part of presets.

To Access the Global (Gbl) Levels Menu:

- Press EDIT and then MENU.
- Select Gbl Levels using the PAGE Encoder.
- Press ENTER.



Input Gain

Range: -8 to 18dB

This parameter sets the input gain of the instrument input where you plug in your guitar.

When you have set the Input gain correctly, the red LED on the Input meters *occasionally* lights up when you hit the guitar hard with a “big” chord on a clean sound.

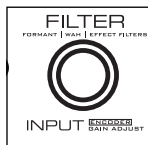

To quickly change the Input gain, hit “EDIT” and turn the Input Gain encoder (switch #1). Hit “EDIT” again to exit back to Play Mode.

Loop Level

Range: 0 to 10dB

This parameter sets how hard you hit the input of the loop section. If you feel that the drive pedals in the loops give more overdrive than when not connected in the G-System, you can use this parameter to compensate.

Loop Headroom

This parameter controls the sensitivity on the input side of the effects section. If the pedals and pre-amp connected

to the loops boost the signal considerably, you can either reduce the output level of these devices, adjust the Loop Headroom parameter – or both. The range of this parameter depends on the Loop level setting.



Levels on Devices in Loops

Max gain on one or more active pedals may cause internal overload in the G-System. Internal overload results in audible digital glitches.

Volume

Range: -100 to 0dB

The volume parameter can control the level either before or after the effects section. This is set up using the Volume Position parameter (see below).

Volume Position

The Volume Position parameter defines where the volume is controlled. The options are:

Input: The volume is controlled right *after* the loops and *before* the effects. This allows for effects such as Delay and Reverb to “hang”, even if you lower the level using an expression pedal.

Output: The volume is controlled *after* the effects. This means that the volume of the entire signal, including effects, is controlled.

Output Level

This parameter sets the overall Output level of the entire G-System. This is where you trim the G-System to your amp’s input. You will have to rely on your ears for this setting, as most amps do not have an input meter. Driving the input of your amp hard may result in overdriving the amp’s input. If this is the sound you are looking for – go for it! If not, lower the Output level of the G-System.



To quickly change the Output level, hit EDIT and turn the Output Level Encoder (Switch #6). Hit EDIT again to return to Play Mode.

Boost Max.

Range: 0 to 10dB

A boost in the digital world is only possible if you do not already operate at maximum level. A boost therefore derives from releasing an attenuation. This parameter sets the general attenuation of the signal, thereby limiting the amount of boost you can set using the Boost menu. Many guitarists feel that 6dB boost is more than enough for solos etc. If you feel the same, set the Boost Max parameter to 6dB. You might be tempted to set Boost max to 10dB all the time. *Don't*, as it will worsen your signal to noise ratio (in this example, by 4dB).

Input Select

Range: Front or Rear.

A guitar can be connected to either the front or the rear of the GFX01. Typically the Front connection is used when GFX01 is mounted in a rack and the Rear connection when G-System is used in its base configuration, assembled on the floor. Front and Rear connections cannot both be open at the same time.

Boost

So you have made a good set of presets and all your levels are well matched ... But wouldn't it be nice if you could just hit a single switch and boost any of your sounds to a "solo" level. With the G-System, you can!

The BOOST switch:

- The boost level (in other words: how much you boost) can be set individually for each preset.
- The maximum boost is 10dB.

If the Boost Lock parameter found in the Utility menu is set to "on", you have a default boost level applied to all presets.

When activating the Boost Lock function in the Utility menu, it is the boost setting of the *currently recalled preset* that will be applied to *all* presets.

Setting up the Boost Level of a Preset

- Press EDIT, then BOOST and set the level using Encoder C.
- Store the preset.

MENU MODE – PEDALS

Expression Pedals: What Are They For?

Expression pedals are used to manually control certain parameters such as volume. Instead of having your entire signal go through 10 meters of cable or more using a regular volume pedal, you can connect an expression pedal and use it to adjust the G-System's volume parameter.

But expression pedals can do much more. How about letting an expression pedal control the pitch as a Whammy pedal, or the level of Delay repeats, or the speed of a Tremolo? There are countless possibilities. For each preset, you can define which parameters the expression pedals should control. This means that in each preset, the pedals can serve different functions. You may, however, prefer a setup where e.g. the expression pedal controlling the volume *always* controls the volume. That is why you can set the pedal assignment as a global parameter.

If we look at the G-System with the Control Board and GFX01 separated, you will see that there are two Expression Pedal Inputs on the GFX01:

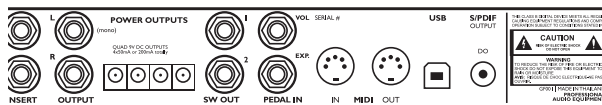

... and two Expression Pedal Inputs on the Control Board:



These connectors are “clones” – meaning that you can control two different parameters per preset, but you can actually hook up two expression pedals *for each function*.

For example, you can place two pedals onstage right next to the Control Board and another two on the “catwalk” for full control when you solo.



All four Expression Pedal Inputs can be individually calibrated.

The Vol Pedal Input is per default assigned to the G-Systems' In Gain parameter and connecting an expression pedal to that connector will automatically allow this pedal to control that parameter. However, as previously described it is entirely up to you what to control with the expression pedals.

Important Note

- True expression pedals can be used to control all types of parameters in G-System.
- Regular volume pedals should only be used to control volume parameters. Using a regular volume pedal to control e.g. whammy or wah effects, will most likely give an unsatisfying result.

Connecting Pedals

Depending on the type of expression pedal used, the pedal should be connected using either a regular mono 1/4" jack-to-jack cable or a stereo 1/4" jack-to-jack cable.

Mono



Stereo

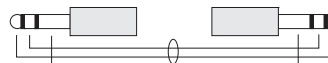

If you are not sure, you may have to try both types. The G-System measures the signal on your expression pedals output connector. Therefore only one cable should be used per expression pedal.

Setting up Your Pedals

In order to secure the best performance of your pedals, you need to calibrate the pedals, then set up the pedal assignment and specify their type. Calibration step by step is explained on the following page of this manual.

Navigation

- Press EDIT and then MENU.
- Select Pedals using the PAGE encoder and press ENTER.
- Now use the PAGE Encoder to select parameters and Encoder C to change their values.

A Brief Overview of the Pedals Menu

<u>Parameter</u>	<u>Options</u>
Volume Ctrl.:	None/Vol/Exp/EncA/EncB/EncC

GFX1 Vol. Type: Off/Momnt/Alt/Exp./Vol.

GFX1 Exp. Type: Off/Momnt/Alt/Exp./Vol.

CTRL Vol. Type: Off/Momnt/Alt/Exp./Vol.

CTRL Exp. Type: Off/Momnt/Alt/Exp./Vol.

Vol. Master: Preset/Global

Exp. Master: Preset/Global

GFX1 Vol. Calib.

GFX1 Exp. Calib.

CTRL Vol. Calib.

CTRL Exp. Calib.

Explanation of Abbreviations:

Vol: Volume – refers to the Volume connectors.

Exp: Expression – refers to the Expression connectors.

GFX1: The Processing Unit – GFX01.

CTRL: Control Board.

Calib: Calibration.

Pot: Potentiometer – as in an expression pedal.

Momnt: Momentary pedal/switch.

Alt: Alternating pedal/switch.

Volume Ctrl. – Volume Control

The first displays show volume control parameters:

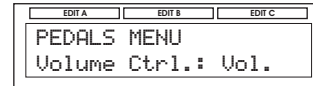

The G-System's volume can be controlled via an expression pedal connected to either the "Vol." or to the "Exp." connectors on the GFX01 and the G-System.

The following options are available:

- None: Volume is not controlled from any connected expression pedals.
- Vol: The expression pedal connected to the Vol. connector on either the GFX01 or the Control Board controls the Volume parameter.
- Exp: The expression pedal connected to the Exp. connector on either the GFX01 or the Control Board controls the Volume parameter.
- EncA, EncB, EncC: Encoder A, B or C controls the Volume parameter.



The Volume parameter can be positioned in two different places: before the Effects section or after the Effects section. This is configured in the Levels menu. Please refer to the "Volume Position" section in this chapter to learn more about these options and their consequences.

MENU MODE – PEDALS

GFX1 Vol. Type – GFX1 Exp. Type

CTRL Vol. Type – CTRL Exp. Type

These four parameters refer to the four Expression Pedal connectors. Use these parameters to tell the G-System what type of pedals you have connected.

- **Momentary:** Use this setting if you have connected a pedal with a momentary switch – in other words, a switch type that is only active as long as it is pressed, such as a keyboard hold pedal.
- **Alternating:** Use this setting if you have connected a pedal with an alternating switch type. The alternating switch type is a switch that stays in one position once it is pressed and needs to be pressed once more to return to its previous state.
- **Exp or Vol:** Select whether it is a volume or an expression pedal you have connected. As explained on page 40, regular volume pedals should only be used to control volume parameters. Expression pedals work well with all types of parameters.

Vol Master & Exp. Master

When a preset change occurs, the value of a parameter can be controlled either by the *expression pedal* or the *preset*. This parameter determines which of the two applies.

There are two options for parameters assigned to pedals:

Preset: The parameter value stored as part of the preset rules – regardless of the current position of the expression pedal controlling the parameter.

Global: The position of the expression pedal is identified at the moment of preset change, and the value stored as part of the preset is overwritten by the pedal.

Example:

Let us say you are using your pedal to control Delay mix

in preset #1. In preset #2, you want to use the pedal to control the Whammy Pitch parameter. Preset # 2 is set up with the Pitch parameter set to 0%. Because you just used your pedal for Delay mix in preset #1, you leave it at 15%. The big question is: When you change to preset #2, do you want the Pitch parameter to stay at 0% – as it is programmed in the preset –, or do you want the pitch to “grab” the 15% position of the pedal?

By setting the Exp. Master parameter to “Global”, the current pedal position affects the controlled parameter immediately after the preset change.

By setting the Exp. Master or Vol. Master parameter to “Preset”, the preset value rules at preset change. The expression pedal will take control of the parameter only once you touch the pedal after preset change.



*Do you want your volume pedal to be global, i.e. not affected by preset changes?
Set the Vol. Master parameter to “Global” and you are in business.*

Calibrating Expression Pedals

GFX1 Vol. Calib. – GFX1 Exp. Calib.

CTRL Vol. Calib. – CTRL Exp. Calib.

As different manufacturers deliver expression and volume pedals with varying potentiometer types, it is important to calibrate the connectors on the G-System to the connected pedals for optimal performance.

Calibrating – Step by Step:

- Make sure that you have connected your pedal to the Volume or Expression Inputs.
- Select one of the four expression pedal connectors you want to calibrate. Select between:
GFX1 Vol. Calib. – GFX1 Exp. Calib.
CTRL Vol. Calib. – CTRL Exp. Calib.
- Press ENTER.
- The LCD now reads “Set Min”.
- Place your pedal in minimum Position (“Heel down”) and press ENTER.

MENU MODE – PEDALS



- The LCD now reads “Set Max”.
- Place your pedal in maximum position (“Toe down”) and press ENTER.



- The LCD reads: “CALIBRATION DONE”.

Using Expression Pedals to Control Specific Parameters

Once the connected Expression/Volume pedals are properly set up and calibrated as explained in the previous section, it is time to define which parameters they should control.

Basics

- Press EDIT to enter Edit Mode.
- Press ENTER two times. You can now access the complete list of parameters in the current preset that can be controlled via the connected pedals and Encoders A, B and C.

The display now looks similar to this:

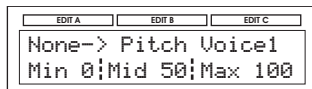

- Use the INPUT Encoder to select the expression pedal you want to setup. Note that Encoders A, B and C also can be used as real-time controllers in Edit Mode.

- Vol: Refers to a pedal connected to the Vol Connector on the GFX01's rear panel or to the Control Board's Vol Connector.
- Exp: Refers to a pedal connected to the Exp Connector on the GFX01's rear panel or to the Control Board's Exp Connector.

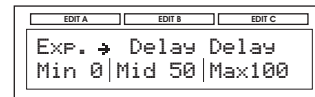

- Enc A, Enc B and Enc C: Refers to Encoders A, B and C when in Edit Mode. Just like expression pedals connected to Vol or Exp, the three Encoders A, B and C can also be assigned and used to control pre-selected parameters.
- Min, Mid and Max: Sets the value corresponding to the Min, Mid and Max position of the expression pedal.

Example

Imagine that you have assigned Encoder A to control Delay Feedback. This means that at the end of the solo or song, you can perform that über-cool trick of increasing the feedback to 100% for that special vintage, non-stop-repeats “on-your-knees” effect.

Setting Up Enc A, B and C

Follow the exact same procedure as explained above in “Using Expression Pedals to Control Specific Parameters”. Note that you do not have to calibrate Encoders A, B and C.

MENU MODE – SWITCHES

Switch Numbers

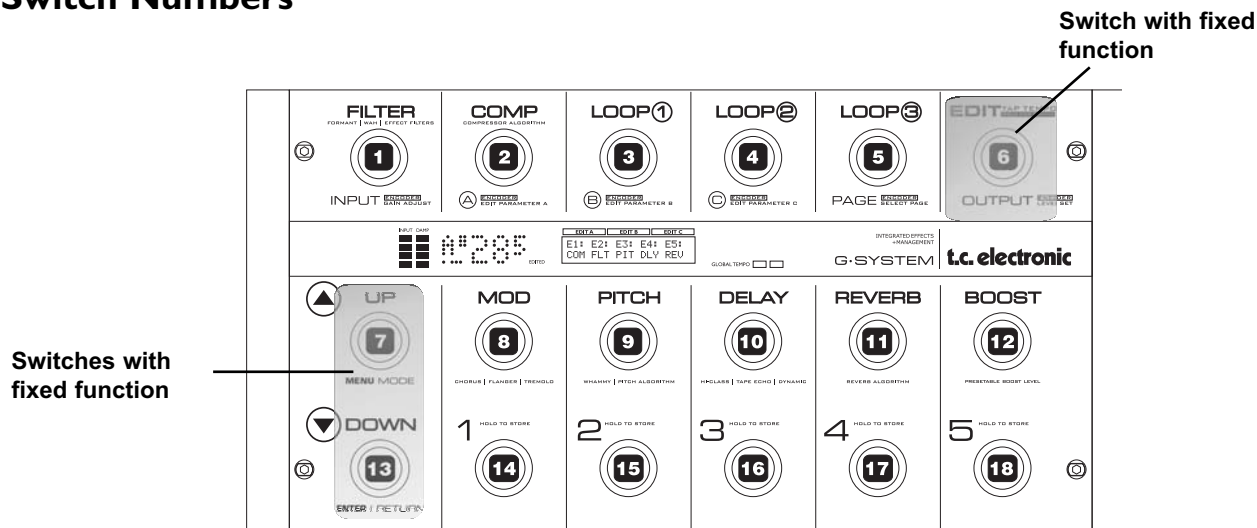

About the Footswitches

The G-System's 18 footswitches have individual default functions. The labels above and below each switch describe those functions.

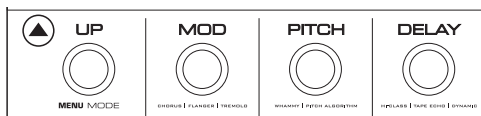

However, it is possible to customize the function of almost every switch* to fit your specific needs.

Example: You would like to have a couple of extra program change switches, or you want to be able to instantly switch all five loops on and off instead of the three loops suggested by the default layout.

* The EDIT switch and the UP/DOWN switches cannot be reassigned to other functions.

Custom Setup of Switch Functions

Follow this step-by-step guide to customize one or more switch functions.

- Press EDIT to enter Edit Mode.
- Press MENU and select Switches using PAGE.
- Press ENTER.
- You will now see a screen similar to this one:

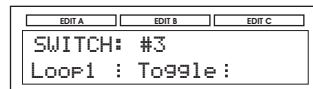

- Use the PAGE Encoder to select the number of the switch you want to re-assign.
- Use Encoder A to select the function for that switch.
- Use Encoder B to select the style (see below).
- Press EDIT to exit to Play Mode.

MENU MODE – SWITCHES

Each of the switch functions has one or more additional parameters that allow even further customization of their functionality. The following table is an overview of the functions available.

Function	Style	Param 3
None	–	–
Filter On/Off	Toggle or Hold	–
Comp On/Off	Toggle or Hold	–
Loop 1 On/Off	Toggle or Hold	–
Loop 2 On/Off	Toggle or Hold	–
Loop 3 On/Off	Toggle or Hold	–
Loop 4 On/Off	Toggle or Hold	–
Insert On/Off	Toggle or Hold	–
Relay	Toggle or Hold	–
Gate	Toggle or Hold	–
Boost On/Off	Toggle or Hold	–
Mod On/Off	Toggle or Hold	–
Pitch On/Off	Toggle or Hold	–
Delay On/Off	Toggle or Hold	–
Reverb On/Off	Toggle or Hold	–
EQ On/Off	Toggle or Hold	–
Preset	Bank:	none
	A0 to A9 (Fact.)	Preset 1 to 5
	B0 to B9 (Fact.)	Preset 1 to 5
	0 to 39 (User)	Preset:1 to 5
Tempo	–	–
Tuner Mute	Toggle or Hold	–
MIDI CC	#0 to 119	–

None

No function.

Toggle/Hold

When Toggle is selected, the selected parameter/effect is switched on or off by hitting the switch once.

When Hold is selected, the function assigned to the switch is held as long as the switch is pressed, and it is released when you release the switch.



Use the Hold option for effects that you just need for a few seconds.

Tap Tempo

Allows you to tap the global G-System tempo.

Tuner Mute

Mutes the output while the Tuner is enabled.

Relay

Switch between Relay settings A and B (Toggle) or temporarily activate setting B (Hold).

Preset

The following parameters allow you to use a switch to recall any preset from the Factory or the User bank. Two parameters must be set:

Bank:

Selects a bank. When set to “none”, the bank position is defined using the UP/DOWN switches.

A0 to A9 and B0 to B9 are Factory banks.

Banks 0 to 39 are User banks.

Preset 1 to 5

Sets the preset to be recalled in the given bank.

MIDI CC

A switch can be assigned to send MIDI CC's between 0 and 119 to G-Systems MIDI out. On the assigned MIDI CC values will toggle between 0 and 127 every time the switch is pressed.

MENU MODE – MIDI

MIDI

Navigation

- Press EDIT and then MENU.
- Select MIDI using the PAGE Encoder and press ENTER.
- Select parameters using the PAGE Encoder.
- Change parameters using Encoder C.

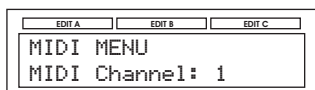

MIDI Channel

Range: Off, 1 to 16 or Omni

When Omni is selected, the G-System receives MIDI information on all channels. When set to Off, the G-System does not respond to any incoming MIDI data.

Program Change In

Range: On/Off

Determines whether the G-System should respond to incoming MIDI program changes or not.

Program Change Out

Range: Off/On/On Map

This parameter and the Prg. Map parameter concern the MIDI program change information sent on MIDI out when a preset is recalled on G-System.

Off: No program changes are sent on MIDI out.

On: Program changes are sent on MIDI out when presets are recalled. Adjacent to the sent program change, an MSB value is also sent. The MSB (Most Significant Bit=Ctrl#0) followed by a valued is used to select a preset bank on the receiving MIDI device. Note that not all MIDI devices are designed to read the MSB.

G-System has 300 preset locations. 100 factory presets and 200 user preset locations.

- When recalling the 100 factory presets in banks A0 to B19, MSB value 0 followed by program changes 0-99 is sent on MIDI out.

- When recalling the 100 user presets in user banks 00 to 19, MSB value 1 followed by program changes 0-99 is sent on MIDI out.

- When recalling the 100 user presets in user banks 20 to 39, MSB value 2 followed by program changes 0-99 is sent on MIDI out.

On Map:

Use this setting to activate the Prg. Map - see next paragraph.

Prg. Map:

Via the MIDI Program Map you are able to select which program change (1-128) should be sent on MIDI out when recalling a user presets. To activate the Prg. Map function the Program Change Out parameter must be set to "On map" to activate the Prg. map.



In the example above Prg. Change no. 6 will be sent on MIDI out when preset 2 in User bank 00 is recalled on the G-System. The Factory bank holds 100 presets. When recalling Factory presets program changes 1 to 100 will be sent on MIDI out.

When the Prg. Map function is used NO MSB (bank select messages) is sent on MIDI out.

Prg. Map Reset

Press ENTER to reset the Program Map.

SysEx ID

Range: 0 to 126

Sets the G-System's SysEx ID for identification in larger MIDI setups.

Dump System

For a complete system backup, press ENTER. All the G-System's basic settings and all User presets are sent via MIDI as a MIDI Data Dump.

Dump Bank*

The entire User bank is sent via MIDI as a MIDI Data Dump when "Execute Dump" is performed.

How to Dump via MIDI – Step by Step:

- Connect the G-System's MIDI Out to the MIDI In of a MIDI sequencing device.
- Set your sequencer to record on all MIDI channels ("Omni") and start recording.
- Set the G-System to dump either all data (System) or User Bank (see above) and press ENTER.

*A computer with a standard MPU 401 MIDI interface is recommended and tested for best results.

External MIDI control

Recalling Presets from an External MIDI Device

To recall a G-System preset using an external device, send a MIDI CC followed by a Program change.

Banks are selected using the following parameters:

Factory bank: Controller #0: Value 0
User bank 1 to 100: Controller #0: Value 1
User bank 101 to 200: Controller #0: Value 2

Utility

Tap Master

Range: Preset or Global

Determines whether at preset change tempo related parameters follow the values set in presets or the globally tapped tempo.

Example:

You have tapped a tempo of 500ms as a global tempo.

The preset you are about to change to has a – tempo dependent – delay time of 350ms. When the Tap Master parameter is set to Preset, the G-System will set the delay time to 350ms (as it is stored in the preset).

When the Tap Master parameter is set to "Global", the G-System will ignore the 350ms value set in the preset and use the (global) 500ms value instead.

Insert Lock (loop 5)

Range: On/Off

This parameter locks the state of the Insert loop to its current state. This feature is typically used when you want a pre-amp connected in the Insert loop to be "on" at all times.

When you activate the Lock feature, the On/Off status for the *currently recalled preset* will be used on all presets.

Boost Lock

This parameter locks the settings of the Boost section. When you activate the Lock feature, the Boost settings for the *currently recalled preset* will be used on all presets.

EQ Lock

This parameter locks the settings of the EQ section. When you activate the Lock feature, the EQ settings for the *currently recalled preset* will be used on all presets.

Relay Lock

Range: On/Off

With Relay Lock set to "On" the relays are locked at their current positions. This means that they will not be altered at preset changes. You can, however, assign a switch to alternate between Relay positions A and B if you like.

RELAYS – FOR AMP CHANNEL SWITCHING

- *Utility continued*

Example: You have a 2 channel amp and would like use on of the switches on the G-System to switch between these channels. At the same time you would like to avoid that the G-System sends out the Relay settings stored with presets at preset recall.

- On you current preset; set Rel.A and Rel.B to two positions that switch the two channels on your amp. This is done via the Edit->Relays menu.
- Set Relay Lock to "On" via the Utility menu.
- Assign a switch to "Relay" via the Edit->Switches menu.

Routing Lock

Range: On/Off

With routing lock set to on the current routing us used on all presets. Note that you may need to make minor level adjustments to certain presets.

Factory Bank Lock

Range: On/Off

When this parameter is set to "on" the factory banks cannot be accessed.

View Angle

Adjusts the backlight of the LCD for better viewing comfort.

Clear System

Resets all System and I/O settings to factory defaults. User presets are left unaltered.

Clear Bank

Deletes all presets in the user bank. All system parameters are left unaltered.

The G-System has two stereo jack connectors which give you access to four relays. Use them to switch channels on your amp or pre-amp.

Relay Switching Menu

- Press EDIT and turn PAGE to select RELAYS.
- Press ENTER.

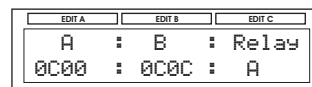

A and B Settings

For each preset, you can define two relay configurations can be set up .

Having two positions allows you to alternate between two amp channels using an assigned switch while staying in the same preset.

Relay

The options are A and B. This parameter sets whether the preset should select relay combination A or combination B at preset change.

The options on each connector are:

- Open
- Tip to Ground
- Ring to Ground
- Tip and Ring to Ground

The following options are available:

1	O O O O	9	C O O C
2	C O O O	10	O C O O
3	O C O O	11	O C C O
4	C C O O	12	O C C C
5	C C C O	13	O C O C
6	C C C C	14	O O C O
7	C O C O	15	O O C C
8	C O C C	16	O O O C

O = Open

C = Closed

As we cannot list schematics of all amps here, we suggest that you simply try which of these options results in the desired channel selection. For your amp this could be:

OOOO = Clean channel
OCCO = Crunch
CCOO = Drive channel

In the Support section on www.tcelectronic.com, you will find schematics on how to make cables for some popular amps. If your amp type is not represented here, please contact a technician for help or consult the manual for your amp or ask the manufacturer for details.

Example

Let us assume the following:

- You have a regular combo-amp with a clean channel and a lead channel.
- The connector for the channel switching on the amp is a regular stereo jack connector.
- You wish to make two presets: one with the clean channel selected and one with the drive channel selected.

Setting up

- Connect a stereo-to-stereo 1/4" jack cable from SW OUT1 or SW OUT2 on the back of the GFX01 to the channel switch connector on your amp.
- Recall the preset you wish to combine with your amp's *clean* channel.
- Scroll through the Rel.A combinations until your amp's clean channel is selected.
Set the Relay parameter to A and store the preset.

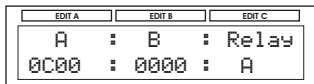

Note that the "A" setting showed above is a pure guess, as we do not know exactly which amp you use.

- Find and recall the preset you wish to combine with your amp's *lead* channel.

- Again, scroll through the Rel.A combinations; but this time, stop once your amp's drive channel is selected.
- Set the Relay parameter to A and store the preset.

This could be the setting for your lead channel:

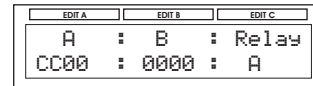

- Store the preset.

What Can the "B" Option Be Used For?

Each preset can store two Relay configurations. You can assign a switch to toggle between these configurations (Toggle) or to temporarily activate the second configuration (Hold).

As a result, the G-System can select the amp channel of your choice at preset change. Then, within that preset, you can use a switch assigned to "Relay" to alternate between Relay A and Relay B settings.

Example:

You have a three channel amp. Clean, Crunch and Lead. You have designed a nice Crunch sound that you use in the beginning of a solo. Later you wish to go to the Lead channel but otherwise keep the same effects.

- Set Relay to "A" and select the Crunch channel using encoder A.

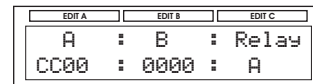

- Then set Relay to B and select the Lead channel using encoder B.
- Set Relay to "A" again and store the preset.
- Now set up a switch to alternate between Relay A and Relay B and you are ready to go.

To learn more about setting up switches, please refer to the "Custom Setup of Switches" section.

THE TUNER

The Tuner in Play Mode

In Play Mode, two arrows indicate whether the played note is in tune or not. When both arrows/triangles are lit, the string is in tune. When only the arrow to the right is lit, the string is pitched a bit too high. When only the arrow to the left is lit, the string is pitched a bit too low.

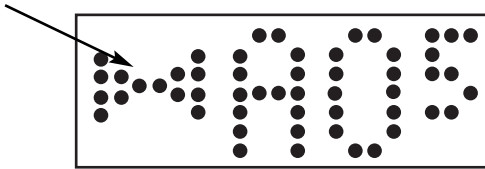

The Tuner in Tuner Mode

In Tuner Mode, the entire display is used to indicate pitch.

To activate Tuner Mode

- Press and hold EDIT for about two seconds to activate Tuner Mode.
- Press EDIT once more to exit.

In Tuner Mode, the current pitch will be indicated in three ways:

- As the nearest note (name).
- Via a “strobe” or “bar” at the bottom of the display.
- Via two “arrows” facing each other.

When both arrows are lit and the strobe is steady, the played note is in pitch.

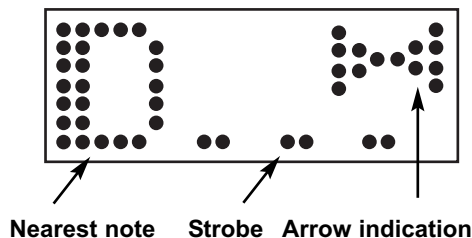

Tuner Mode Parameters

- Press and hold EDIT for two seconds to enter Tuner Mode.
- Use PAGE to select parameters.
- Use Encoder A, B or C to change values.

Output

Range: On/Off

You may wish to mute the G-System's outputs in Tuner Mode – especially if you do not use an expression pedal for volume control. In this case, set Output to off.

Display

The G-System's Tuner has two different indication modes. These comprise the indication at the bottom of the big red Tuner and the preset number display.

Bar

A bar appears at the bottom of the tuner display. When the bar is visible, the note played is *not* in tune. The longer the bar, the more out of tune the note.

Strobe

In Strobe Mode, a pattern of two dots will move either towards the left or towards the right, depending on whether the played note is too high or too low. Tune the string until the pattern of dots stays in one position.

Tuner Reference

Range: 420 to 460Hz

This parameter sets the reference frequency for the Tuner. The default setting is 440Hz.

TAP TEMPO

Tap Tempo: Hit Twice or More!

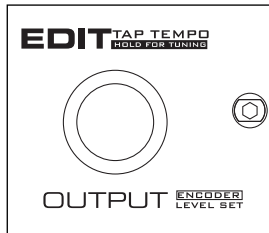

The Tap Tempo function allows you to tap the Global tempo. Tap tempo is averaged from the first two taps and up to the last ten.

Tap Tempo is always shown in both milliseconds (ms) and beats per minute (BPM).

EDIT A	EDIT B	EDIT C
BPM	TEMPO	TIME
94		638ms

The interval between taps must not be shorter than 200ms or longer than 2000ms.

The Global Tapped Tempo is used to set the corresponding tempo parameters in the relevant effect pages (see the Effect section for more information).

In the Tempo menu, Encoders A and C can also be used to adjust the tempo.



Hitting TAP TEMPO two times within two seconds will initiate Tempo mode. Hit any other switch to interrupt the tapping sequence.

EFFECTS – FILTER

This section of the manual describes the G-System's effects and their parameters. To learn how to navigate the G-System's menus, please refer to the preceding chapters.

Resonance Filter

The G-System's Resonance filter is basically a hi-cut filter with adjustable Q-factor (Resonance). With increased Resonance value, the filter peak at the cutoff frequency gets very narrow and steep. This phenomenon is the very core of the characteristic sound of resonance filters.

Style

Range: 2nd or 4th

The Style parameter changes the steepness of the filters. 2nd order filters are 12dB/Octave while 4th order filters are 24dB/Octave. 4th order filters will "ring" or resonate more than 2nd order filters.

Hi-Cut

Range: 160Hz to 14kHz

Determines the frequency above which the hi-cut filter will attenuate the high-end frequencies of the generated effect.

Resnce – Resonance

Range: 0 to 100%

Sets the amount of resonance on the hi-cut filter.

OutLev – Out Level

Range: -100 to 0dB

This parameter sets the overall Output level of this effect.

Enable

Range: Off/On

The effect's status. All settings are stored as part of the preset even if this particular effect is disabled.

Touch Res Filter – Additional Parameters

The Touch Resonance filter creates an effect similar to a Touch Wah. The sweep through a frequency range is controlled via the Input's dynamics.

Sense – Sensitivity

Range: 0 to 10

The sensitivity should be set according to the Input level on the Filter block. The lower a setting, the harder the effect section should be hit to create the "whack" effect.

Response

Range: Slow or Fast

This parameter sets the response time, i.e. how fast the "quack" should occur when you hit the strings.

Fmax – Frequency Max

Range: 1kHz to 10kHz

This parameter can limit range of the sweep. Most likely you will find a full range being too harsh and high-end. You will probably find settings between 2kHz and 4kHz to prove excellent.

Auto Resonance Filter – Additional Parameters

Speed

Range: 0.050Hz to 20Hz

This parameter sets the speed of the effect.

Tempo

Range: Ignore, 2 to 1/32T (T= Triplet & D= Dotted)

When set to any value between 1 and 1/32T, the G-System's Global Tempo is subdivided according to this setting. When set to "Ignore", the speed set by the Speed parameter is used instead.

Shape

Range: Triangle or Sine

Defines the type of curve used. The Triangle shape has a sharp peak point, while the Sine type gives a smoother shift.

Fmax – Frequency Max

Range: 1kHz to 10kHz

This parameter can limit the range of the sweep. Most likely you will find a full range being too harsh and high-end.

You will probably find settings between 2kHz and 4kHz to prove excellent.

Wah Wah

With this effect type, you can create the same effect as with a dedicated wah pedal, which you can control manually. All you need to do is assign an expression pedal to control the Sweep parameter.

When you select a Factory preset using this Wah Wah effect, an expression pedal connected to the Exp. connector is automatically assigned to control this parameter.

Sweep (Freq)

Range: 0 to 100%

With an expression pedal set up to control this parameter, you have created a wah pedal.

Range (Instr Mode)

Range: Low or high

This parameter sets which frequency areas should primarily be emphasized.

AutoOn

Range: Off, 0.3s, 0.5s, 1s, 3s, 5s, 10s or Inf

When set to "off" the Wah effect is switched on/off using the FILTER switch just like any other regular effect.

With any other setting the Wah effect is automatically switched on when the expression pedal controlling the Sweep parameter is moved.

Once the pedal is left in a fixed position the Wah effect is turned off after the period of time set by this parameter. "0.3" seconds is almost instantly - "Inf" means never.

OutLev – Out Level

Range: -100 to 0dB

This parameter sets the overall Output level of this effect.

Enable

Range: Off/On

The effect's status. All settings are stored as part of the preset even if this particular effect is disabled.

EFFECTS – FILTER

Touch Wah

The wah effect occurs when a relatively narrow frequency area is boosted and swept through a frequency range. The sweep is controlled by the input dynamics. This means: the harder you hit the strings, the higher the boosted frequency will be.

Sense – Sensitivity

Range: 0 to 10

Adjust the sensitivity according to the level present on the input. Be aware that changing any level parameter on devices prior to the Touch Wah effect will require a different sensitivity setting to get the same Touch Wah “feel”.

Resp – Response

Range: Slow or Fast

This parameter determines the speed of the sweep.

Range (Instr Mode)

Range: Low or High

This parameter determines whether the Touch Wah is particularly sensitive to high or low input frequencies.

OutLev – Out Level

Range: -100 to 0dB

This parameter sets the overall Output level of this effect.

Enable

Range: Off/On

The effect’s status. All settings are stored as part of the preset even if this particular effect is disabled.

Auto Wah

The wah effect occurs when a relatively narrow frequency area is boosted and swept through a frequency range.

The sweep is controlled by a low frequency oscillator (LFO).

Speed

Range: 0.050Hz to 20Hz

This parameter sets the speed of the effect.

Tempo

Range: Ignore, 2 to 1/32T (T= Triplet & D= Dotted)

When set to any value between 2 and 1/32T, the G-System’s Global Tempo is subdivided according to this setting. When set to “Ignore”, the speed set by the Speed parameter is used instead.

Shape

Range: Triangle or Sine

Sets the shape of the frequency boost.



Range (Instr Mode)

Range: Low or High

Determines whether the Auto Wah is particularly sensitive to low or high input frequencies.

OutLev – Out Level

Range: -100 to 0dB

This parameter sets the overall Output level of this effect.

Enable

Range: Off/On

The effect’s status. All settings are stored as part of the preset even if this particular effect is disabled.

Formant Filters – Introduction

The Formant filters are somewhat special. The characteristic vowels of the human speech can also be described as formants. Imagine a pedal that does not say “WAH WAH”, but instead goes “OOWEEAA-OOWEEAA”.

If you set up an expression pedal to control the sweep parameter, you can use the pedal to sweep through the vowel sounds.

Formant parameters – Generic

Low, Mid & High

Range: Heat, Hit, Head, Had, But, Father, All, Boot, Foot or Bird.

We have used names phonetically similar to the types of sounds emulated by that particular formant filter.

Sweep

Range: 0 to 100%

Assign an expression pedal to control the Sweep parameter, and you have full “live” control of the emulated vowels.

Bright

Range: 0 to 100%

Depending on the Low, Mid and High settings, you may need to adjust the high-end frequencies of this effect.

Resonance

Range: 0 to 100%

Use this parameter to increase filter emphasis. Use it with caution, as high settings combined with certain vowels may sound very harsh.

OutLev – Out Level

Range: -100 to 0dB

This parameter sets the overall Output level of this effect.

Enable

Range: Off/On

The effect's status. All settings are stored as part of the preset even if this particular effect is disabled.

Touch Formant – Additional Parameters

The Touch Formant effect is controlled by the input dynamics – similar to a Touch Wah.

Sensitivity

Range: 0 to 10

The Sensitivity parameter must be set according to the base level of your particular preset.

Response

Range: Slow or Fast

This parameter determines the speed of the sweep when you hit the strings.

Auto Formant – Additional Parameters

Speed

Range: 0.050 to 20Hz

This parameter sets the speed of the effect.

Tempo

Range: Ignore, 2 to 1/32T (T= Triplet & D= Dotted)

When set to any value between 1 and 1/32T, the G-System's Global Tempo is subdivided according to this setting. When set to “Ignore”, the speed set by the Speed parameter is used instead.

LFO Shape

Range: Triangle or Sine

This parameter sets the shape of the frequency boost.

Bright

Range: 0 to 100%

Depending on the Low, Mid and high settings you may need to adjust the high-end frequencies of this effect.

EFFECTS – COMPRESSOR

Compressor

Introduction

A Compressor is used to control the dynamic content of a signal. It can be used both for levelling out the signal's dynamics (thereby letting your guitar sound stand out clearer) and also for more radical, very recognizable effects. The G-System provides three basic types of compression. They assist you in finding the most appropriate sound for your particular application.

Advanced Mode

This mode gives you access to all the common compressor parameters. This means you have full control over the compressor.

Sustaining Mode & Percussive Mode

In these modes, we offer fewer but very effective “handles”. While the Sustaining Mode is used to achieve rather extreme compression effects, the Percussive Mode is more suitable for limiting purposes.

Illustration – Basic Compression

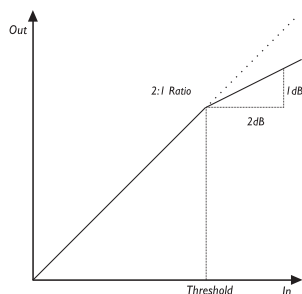

As this illustration shows, the output signal is attenuated in accordance to the set ratio when the input signal exceeds the Threshold point. The Attack parameter specifies how fast the attenuation is achieved. Use the Gain parameter to compensate the overall loss of level that might result from compression.

Advanced Type

This type offers full control over all compression parameters.

Threshold

Range: -40dB to 0dB

When the signal exceeds the set Threshold point, the Compressor is activated. The signal's level above this Threshold point is processed according to the settings of the Ratio, Attack and Release parameters (see below).

Ratio

Range: Off, 12:1 to Infinite:1

This parameter determines how hard the signal is compressed. (see illustration above).

Example: With a Ratio setting of 2:1, an Input signal with 4dB above Threshold is reduced to only 2dB on the Output. The Infinite setting gives you a Limiter function.

Attack

Range: 1ms to 140ms

The Attack time is the response time of the Compressor. The shorter the Attack time, the sooner the Compressor will reach the specified Ratio after the signal rises above the Threshold point.

Release

Range: 50 to 2000ms

The Release time is the time it takes for the Compressor to release the gain reduction of the signal after the Input signal drops below the Threshold point again.

Gain

Range: -12 to +12dB

Use the Gain parameter to compensate for the level changes caused by the applied compression.

Enable

Range: Off/On

The effect's status. All settings are stored as part of the preset even if this particular effect is disabled.

Sustaining and Percussive Types

The Sustaining and Percussive Types hold fewer handles than the Standard mode. Individually tuned these types allow you to easily setup commonly used compression styles.

Use the Sustaining type to achieve the subtle compression settings that will give you plenty of sustain without “smashing” the sound too hard.

Use the Percussive type to obtain the hard, obvious and easy recognizable compression often achieved with classic stomp box compressors

Though tuned differently the two types hold common parameters.

Drive

Range: 1 to 20

A combination of Threshold and Ratio parameters that sets the compression amount. Though auto make-up gain is applied you may need to adjust the level slightly using the Gain parameter when extreme settings are used.

Response

Range: 1 to 10

Sets the time it takes for the Compressor to release the compression. The lower setting the more you will hear the compression.

Gain

Range: -12 to +12dB

Depending on the settings of Drive and Response parameters you may need to adjust the Gain.

Enable

Range: Off/On

The effect's status. All settings are stored as part of the preset even if this particular effect is disabled.

EFFECTS – MOD

Chorus

Introduction

The G-System offers two types of Chorus: the simple *Classic Chorus* and the *Advanced* type that includes a couple of extra parameters.

The basic idea of a chorus effect is to split the signal and pitch modulate one of the signals slightly, then mix the two signals again.

Classic Chorus

Speed

Range: 0.050Hz to 20Hz

This parameter sets the speed of the effect.

Tempo

Range: Ignore, 2 to 1/32T (T= Triplet & D= Dotted)

When set to any value between 1 and 1/32T, the G-System's Global Tempo is subdivided according to this setting. When set to "Ignore", the speed set by the Speed parameter is used instead.



The Tap Master parameter – located in the Utility menu – specifies whether the *Global* tempo or the tempo set by the Speed parameter in each preset should be used at preset change.

Depth

Range: 0 to 100%

The Depth parameter specifies the intensity of the effect. The value represents the amplitude of the modulating waveform.

Hi-Cut

Range: 20Hz to 20kHz

This parameter reduces the high-end frequencies in the Chorus effect. Try using this parameter if you feel the Chorus effect is too dominant in your sound and turning down the Mix or Out level doesn't give you the dampening of the Chorus effect you are looking for.

Mix

Range: 0 to 100%

This parameter sets the relationship between the dry signal and the level of the effect in this Effect Block.

OutLev – Out Level

Range: -100 to 0dB

This parameter sets the overall Output level of this effect.

Enable

Range: Off/On

The effect's status. All settings are stored as part of the preset even if this particular effect is disabled.

Advanced Chorus

Additional parameters to the Classic Chorus:

Cho DI – Chorus Delay

Range: 0 to 50ms

As described earlier, a Chorus/Flanger is basically a Delay being modulated by an LFO. This parameter allows you to change the length of that Delay. A typical Chorus uses Delays at approximately 10ms, while a Flanger uses Delays at around 5ms.



Though this not how a Chorus is normally used, you may enjoy the “slap-back” resulting from longer Delay times such as 30 to 50ms.

Ratio – Golden Ratio

Range: Off/On

TC research has shown that when the *speed* of a modulation effect is increased, its *depth* should be decreased accordingly to achieve the same amount of perceived modulation. When the Golden Ratio parameter is set to On, this value is automatically calculated.

Golden Ratio is a feature inherited from the classic TC 2290 processor.

Phase Reverse

Range: Off/On

Setting this parameter to On reverses the phase of the processed signal in the right channel. This gives a very wide Flange effects and a less defined sound.

Flanger – Introduction

The Flanger belongs to the same “family” of modulation effects as the Chorus effect. The signal is split, and one of the signals is pitch modulated.

The characteristic “flanging” sound occurs when part of the signal is slightly delayed and fed back to the input of the effect algorithm. Experiment with the Feedback parameter to get a feeling for the achievable effects.

Classic Flanger

Speed

Range: 0.050Hz to 20Hz

This parameter sets the speed of the effect.

Tempo

Range: Ignore, 2 to 1/32T (T= Triplet & D= Dotted)

When set to any value between 1 and 1/32T, the G-System’s Global Tempo is subdivided according to this setting. When set to “Ignore”, the speed set by the Speed parameter is used instead.



The Tap Master parameter – located in the Utility menu – specifies whether the *Global* tempo or the tempo set by the Speed parameter in each preset should be used at preset change.

Depth

Range: 0 to 100%

The Depth parameter specifies the intensity of the effect. The value represents the amplitude of the modulating waveform.

Hi-Cut

Range: 20Hz to 20kHz

This parameter reduces the high-end frequencies in the Flanger effect. Try using this parameter if you feel the Flanger effect is too dominant in your sound and turning down the Mix or Out level doesn’t give you the dampening of the Flanger effect you are looking for.

EFFECTS – MOD

FeedB – FeedBack

Range: -100 to 100

This parameter controls the amount of feedback (Resonance) of the short modulated delay that causes the Flanging effect. When the Feedback is set too high (above approximately 90% to 95%), this might introduce *internal* feedback, resulting in a squealing noise that in most cases is unwanted in flanging effects. Be aware of this side-effect when experimenting at high volumes. Negative values inverse the phase of the signal that is fed back to the algorithm's Input.

FB Cut – Feedback hi-cut

Range: 20Hz to 20kHz

A parameter that can attenuate the high-end frequencies of the resonance created with the Feedback parameter.

Mix

Range: 0 to 100%

This parameter sets the relationship between the dry signal and the level of the effect in this Effect Block.

OutLev – Out Level

Range: -100 to 0dB

This parameter sets the overall Output level of this effect.

Enable

Range: Off/On

The effect's status. All settings are stored as part of the preset even if this particular effect is disabled.

Advanced Flanger

Additional parameters to the Classic Flanger:

Fla DI – Flanger Delay

Range: 0 to 50ms

Typically, Delay values around 5ms are used for Flanging effects, whereas Chorus effects occur with Delay times around 10ms. You are free, however, to choose Delay times from 0 to 50ms.

PhaRev – Phase Reverse

Range: Off/On

Setting this parameter to On reverses the phase of the processed signal in the right channel. This gives a very wide Flange effects and a less defined sound.

Ratio – Golden Ratio

Range: Off/On

TC research has shown that when the *speed* of a modulation effect is increased, its *depth* should be decreased accordingly to achieve the same amount of perceived modulation. When the Golden Ratio parameter is set to On, this value is automatically calculated. Golden Ratio is a feature inherited from the classic TC 2290 processor.

Vibrato

The Vibrato effect modulates the pitch of the incoming signal. The result is similar to the vibrato technique used by vocalists. In contrast to a Chorus or Flanger effect, no direct signal is combined with the pitch-modulated signal.



Speed

Range: 0.050Hz to 20Hz
Sets the speed of the effect.

Tempo

Range: Ignore, 2 to 1/32T (T= Triplet & D= Dotted)
When set to any value between 1 and 1/32T, the G-System's Global Tempo is subdivided according to this setting. When set to "Ignore", the speed set by the Speed parameter is used instead.



The Tap Master parameter – located in the Utility menu – specifies whether the *Global* tempo or the tempo set by the Speed parameter in each preset should be used at preset change.

Depth

Range: 0 to 100%
The Depth parameter specifies the intensity of the effect. The value represents the amplitude of the modulating waveform.

Hi-Cut

Range: 20Hz to 20kHz
This parameter reduces the high-end frequencies in the Vibrato effect. Try using this parameter if you feel the effect is too dominant.

OutLev – Out Level

Range: -100 to 0dB
This parameter sets the overall Output level of this effect.

Enable

Range: Off/On
The effect's status. All settings are stored as part of the preset even if this particular effect is disabled.

EFFECTS – MOD

Vintage Phaser & Smooth Phaser

Introduction

The G-System provides two very effective phaser types. The *Vintage Phaser* will give you a phasing effect similar to the one found in old stomp boxes. The *Smooth Phaser* is more subtle and less dominant.

The Vintage Phaser utilizes *four* all-pass filters. These filters create a comb-looking effect on the sound spectrum. When the filtered sound is mixed with the direct sound, a “phasing” effect occurs.

The Smooth Phaser utilizes *twelve* all-pass filters. Due to the higher number of filters, the Smooth Phaser simply sounds smoother than the Vintage type.

Parameters and value ranges for the two Phaser types are identical. The difference is the filter at the core of the two Phaser models.

Speed

Range: 0.050Hz to 20Hz
Sets the speed of the effect.

Tempo

Range: Ignore, 2 to 1/32T (T= Triplet & D= Dotted)
When set to any value between 2 and 1/32T, the G-System’s Global Tempo is subdivided according to this setting. When set to “Ignore”, the speed set by the Speed parameter is used instead.



The Tap Master parameter – located in the Utility menu – specifies whether the *Global* tempo or the tempo set by the Speed parameter in each preset should be used at preset change.

Depth

Range: 0 to 100%
The Depth parameter specifies the intensity of the effect. The value represents the amplitude of the modulating waveform.

Fb – FeedBack

Range: -100 to +100%
This parameter controls the amount of feedback in the Phaser. Negative values inverse the phase of the signal that is fed back to the algorithm’s Input.

Range

Range: Low to High
Determines whether the phasing effect should be mainly on the high or low-end frequencies.

Rev – Reverse

Range: On/off
Reversing the phase in one of the channels creates a much wider sounding phasing effect.

Mix

Range: 0 to 100%
This parameter sets the relationship between the dry signal and the level of the effect in this Effect Block.

OutLev – Out Level

Range: -100 to 0dB
This parameter sets the overall Output level of this effect.

Enable

Range: Off/On
The effect’s status. All settings are stored as part of the preset even if this particular effect is disabled.

Tremolo

Introduction

A Tremolo is basically a change of the signal level controlled by an LFO. The G-System offers variations of this effect; ranging from soft and smooth to hard and aggressive.

Speed

Range: 0.050Hz to 20Hz

This parameter sets the speed of the effect.

Tempo

Range: Ignore, 2 to 1/32T (T= Triplet & D= Dotted)

When set to any value between 1 and 1/32T, the G-System's Global Tempo is subdivided according to this setting. When set to "Ignore", the speed set by the Speed parameter is used instead.



The Tap Master parameter – located in the Utility menu – specifies whether the *Global* tempo or the tempo set by the Speed parameter in each preset should be used at preset change.

Depth

Range: 0 to 100%

This parameter sets the intensity of the effect. A 100% setting means that the signal is completely muted between signal peaks.

Type

Range: Soft or Hard (Sinus or Square)

Two waveforms are available as modulation sources for the Tremolo effect. Setting this parameter to Hard results in a steeper effect. Listen and choose the appropriate option.

Sine



Square



Width

Range: 0 to 100%

If you set this parameter e.g. to 20% with a Type setting of Hard, the waveform will be on for 80% of one period. With a Type setting of Soft, a 50% setting would yield a full sine wave, whilst 0% and 100% would yield a crest-to-peak and peak-to-crest curve, respectively.

Pulsewidth



Hi-Cut

Range: 20Hz to 20kHz

This parameter attenuates the high frequencies of the Tremolo effect. Use the hi-cut filter to create a less dominant Tremolo effect without changing the effect's Depth.

OutLev – Out Level

Range: -100 to 0dB

This parameter sets the overall Output level of this effect.

Enable

Range: Off/On

The effect's status. All settings are stored as part of the preset even if this particular effect is disabled.

EFFECTS – MOD

Panner

Introduction

The Panner simply pans the signal between the left and the right channel. Use this for extreme stereo perspective effects.

Speed

Range: 0.050Hz to 20Hz

Sets the speed of the effect.

Tempo

Range: Ignore, 2 to 1/32T (T= Triplet & D= Dotted)

When set to any value between 1 and 1/32T, the G-System's Global Tempo is subdivided according to this setting. When set to "Ignore", the speed set by the Speed parameter is used instead.



The Tap Master parameter – located in the Utility menu – specifies whether the *Global* tempo or the tempo set by the Speed parameter in each preset should be used at preset change.

Depth

Range: 0 to 100%

When you set this parameter to 100%, the signal will sweep fully from the left to right. You will find, however, that for most applications, a more subtle setting is more appropriate, as it blends more elegantly with the overall sound.

OutLev – Out Level

Range: -100 to 0dB

This parameter sets the overall Output level of this effect.

Enable

Range: Off/On

The effect's status. All settings are stored as part of the preset even if this particular effect is disabled.

Pitch Shifter

The G-System's Pitch Shifter gives you two voices, each with a fixed pitch distance to the Input note. The maximum range for this effect is +/- one octave. The signal processing within the G-System happens so fast that you will never notice any "searching" for notes as with many older octaver units or octaver stomp boxes. You might try lowering one voice to -1200 cents (100 Cent equal one semitone). At a Mix level of 100 (full effect, no dry signal), you will be able to get at pretty good bass simulation.

Voice 1

Range: -1200 to 1200 Cent

This parameter specifies the pitch of the first voice. As 100 Cent equal 1 semitone, you can select any interval between one octave below the Input pitch to one octave above it.

Voice 2

Range: -1200 to 1200 Cent

This parameter specifies the pitch of the second voice. As 100 Cent equal 1 semitone, you can select any interval between one octave below the Input pitch to one octave above it.

Pan 1

Range: -50 to 50

This parameter sets the stereo position of the first voice.

Pan 2

Range: -50 to 50

This parameter sets the stereo position of the second voice.

Delay 1

Range: 0 to 350ms

This parameter sets the Delay time for the first voice.

Delay 2

Range: 0 to 350ms

This parameter sets the Delay time for the second voice.

FB1

Range: 0 to 100%

This parameter determines how often the first voice will be repeated by the Delay.

FB2

Range: 0 to 100%

This parameter determines how often the second voice will be repeated by the Delay.

Mix

Range: 0 to 100%

This parameter sets the relationship between the dry signal and the level of the effect in this Effect Block.

OutLev – Out Level

Range: -100 to 0dB

This parameter sets the overall Output level of this effect.

Enable

Range: Off/On

The effect's status. All settings are stored as part of the preset even if this particular effect is disabled.

EFFECTS – PITCH

Octaver

The Octaver gives you an additional voice with a fixed pitch distance of either one or two octaves above or below the Input note.

Dir - Direction

Range: Up or Down

This parameter sets whether the added voice should be above or below the input note.

Range

Range: 1 or 2 octaves

This parameter sets the interval of the added voice. Use the Direct parameter to determine whether the added voice should be above or below the Input signal.

Mix

Range: 0 to 100%

This parameter sets the relationship between the dry signal and the level of the effect in this Effect Block.

OutLev – Outlevel

Range: -100 to 0dB

This parameter sets the overall Output level of this effect.

Enable

Range: Off/On

The effect's status. All settings are stored as part of the preset even if this particular effect is disabled.

Whammy

The Whammy effect allows you to control the pitch of an added voice with an external Expression pedal.

For Factory presets including the Whammy effect, the Expression pedal connected to the Expression Pedal Input automatically controls the Pitch parameter, i.e. it acts as a Whammy Pedal.

Pitch

Range: 0 to 100%

This parameter sets the amount of pitch shift relative to the Range setting. A connected pedal adjusts this parameter.

Dir – Direction

Range: Up – Down

This parameter determines whether the attached Expression pedal should *increase* or *decrease* pitch when moved in either direction.

Per default, pitch is up when the pedal is at “toe down position”, i.e. this is the “Up” position.

Range

Range: 1-Oct/2-Oct

This parameter sets the range of the pitching effect. Select 2-Oct for an extreme and 1-Oct for the more commonly used, subtle Whammy effect.

OutLev – Out Level

Range: -100 to 0dB

This parameter sets the overall Output level of this effect.

Enable

Range: Off/On

The effect's status. All settings are stored as part of the preset even if this particular effect is disabled.

Detune

The Detune effect is – to some extent – similar to a Chorus: The source signal is split and a specified amount of the signal is detuned by an adjustable amount of Cents (100 Cent = 1 semitone). The main difference between the Detune effect and the Chorus effect is that the Detune amount does not change: the modulating pitch is specified as an offset to the original pitch. The Detune effect comprises two voices. If you think your sound is simply too direct and clean, try a setting with only a few Cent off on both voices – e.g. +2 Cent on Voice 1 and -3 Cent on Voice 2.

Voice1

Range: -100 to 100

This parameter determines the pitch offset for the first Voice in the Detune block.

Voice2

Range: -100 to 100

This parameter determines the pitch offset for the second Voice in the Detune block.

Delay1

Range: 0 to 350ms

This parameter specifies the Delay for the first Voice.

Delay2

Range: 0 to 350ms

This parameter specifies the Delay for the second Voice.

Mix

Range: 0 to 100%

This parameter sets the relationship between the dry signal and the level of the effect in this Effect Block.

OutLev – Out Level

Range: -100 to 0dB

This parameter sets the overall Output level of this effect.

Enable

Range: Off/On

The effect's status. All settings are stored as part of the preset even if this particular effect is disabled.

EFFECTS - PITCH

Intelligent Pitch Shifter

The G-System Intelligent pitch-shifter is a 2 voice pitch-shifter that allows you to play harmonies within a variety of scales in any key. The range of the voices range from minus 13 scale-steps below to 13 scales steps above which equals +/- one octave plus a diatonic sixth.

Key

To allow the intelligent pitch-shifter to generate the correct voices it is necessary to enter which key you are playing in. Keys are listed as: C, C#, D, D#, E, F, F#, G, G#, A, A#, and B.

Scale

With the scale parameter you set the type of scale you intend to play. G-System covers the following scales-types:

Label	Full name	Scale steps
Ionian	Ionian	1,2,3,4,5,6,7
Dorian	Dorian	1,2,b3,4,5,6,b7
Phrygi	Phrygian	1,b2,b3,4,5,b6,b7
Lydian	Lydian	1,2,3,#4,5,6,7
Mixoly	Mixolydian	1,2,3,4,5,6,b7
Aeolia	Aeolian	1,2,b3,4,5,b6,b7
Locria	Locrian	1,b2,b3,4,b5,b6,b7
PntMin	Pentatonic minor	1,b3,4,5,b7
PntMaj	Pentatonic major	1,2,3,5,6
Blues	Blues	1,b3,4,b5,5,b7
DimHlf	Diminished half	1,b2,b3,3,b5,5,6,b7
DimWhl	Diminished whole	1,2,b3,4,b5,b6,6,7
Whole	Wholetone	1,2,3,#4,#5,b7
MelMin	Melodic minor	1,2,b3,4,5,6,7
HrmMin	Harmonic minor	1,2,b3,4,5,b6,7
SupLoc	Super Locrian	1,b2,b3,b4,b5,b6,b7
Lyd b7	Lydian b7	1,2,3,#4,5,6,b7
PhryMa	Phrygian major	1,b2,3,4,5,b6,b7

Voice 1-2

Range: -13 to Unison to 13

The intelligent pitch-shifter can add two voices within the selected scale. The pitch-shifter automatically calculates the correct interval according to the played note, selected scale type and key.

Level 1-2

Range: -100 to 0dB

Sets the individual levels of the two voices.

Pan Position 1-2

Range: -/+50

Controls the panning position of each of the two voices. 0 is center position. By panning the voices you can achieve a very wide spread sound.

Delay 1-2

Delay range: 0-50ms

To get a natural sounding result it is obvious to simulate that no two guitarist would play notes precisely at the same time. To simulate this you can delay the harmony voices slightly. Just 10-20ms of delay will give in a smooth and natural sounding result.

Mix

Range: 0 to 100%

Sets the overall mix between the dry and processed signal.

OutLev – Out Level

Range: -100 to 0dB

This parameter sets the overall Output level of this effect.

Enable

Range: Off/On

The effect's status. All settings are stored as part of the preset even if this particular effect is disabled.

Delay – Introduction

The G-System offers not only standard Delay types but also a few new ones. We believe that the following types should cover all your delay needs:

- **Single Delay**
- **Tape Delay**
- **Reverse**
- **Lo-Fi**
- **Ping Pong**
- **Dynamic Delay**
- **Dual Delay**

All delays feature true “spillover” – meaning the repeats of the delay can ring out when you change presets. The tempo of the delay can be defined in relation to a Global tempo, which can be tied to an incoming MIDI clock.

Common Parameters – Delay

The following parameters are identical for all Delay types. Parameters specific to certain delays are described in the relevant sections.

Delay

Range: 0 to 1800ms

This parameter sets the time between the delay repeats. This is also known as the “length” of the delay.

Tempo

Range: Ignore, 2 to 1/32T (T= Triplet & D= Dotted)
When set to any value between 1 and 1/32T, the G-System’s Global Tempo is subdivided according to this setting. When set to “Ignore”, the speed set by the Speed parameter is used instead.



The Tap Master parameter – located in the Utility menu – specifies whether the *Global* tempo or the tempo set by the Speed parameter in each preset should be used at preset change.

Fb – Feedback

Range: 0 to 120%

This parameter sets the amount of feedback from the output of the effect back to its input. Use the Feedback parameter to set how many repeats of the signal you would like to have.



Please use high settings with extreme caution. Due to the spillover feature of the G-System, there is no way to immediately cut off the delay when you get an internal feedback at settings above 100%. If you do get internal feedback, either switch to a different Delay Type or to a different preset that uses the Delay, two times in succession.

Fbfcut – Feedback LoCut

Range: 20Hz to 20kHz

Use this parameter to attenuate the frequencies below a given frequency.

As with the Feedback Hi-Cut parameter, the delays may blend in more nicely with the overall sound if you “thin out” the effect at the low end.

Fbhcut – Feedback Hi-Cut

Range: 20Hz to 20kHz

With digital technology, every delay can be a precise reproduction of the Input signal. But especially with long Delay times, this is not always desirable, as these pristine delays may disturb the original signal and result in a “washed-out” sound. To compensate for this, use the hi-cut filter, thereby emulating analog or tape style delay units.

The Feedback Hi-Cut parameter attenuates the frequencies over the set frequency, resulting in a more “analog” sound that in many cases that will blend in better with the overall sound.

Mix

Range: 0 to 100%

This parameter sets the relationship between the dry signal and the level of the effect in this Effect Block.

EFFECTS – DELAY

OutLev – Out Level

Range: -100 to 0dB

This parameter sets the overall Output level of this effect.

Enable

Range: Off/On

The effect's status. All settings are stored as part of the preset even if this particular effect is disabled.

Single Delay

The Single Delay effect is the most simple and basic delay type in the G-System. It comprises a single delay line with all the common parameters.

All Common Parameters

Please refer to the section “Delay – Introduction” for a description of this Delay's parameters.

Tape Delay

This delay simulates historical, tape-based delays, including the clipping sound that occurs when the Feedback parameter is yanked past the 100% point. Try experimenting with a high Feedback level combined with high and low cut filters.

In addition to the “common” parameters described in the introduction of the delay section, this delay has the following parameters:

Drive

Range: 0 to 24dB

Use this parameter to simulate the slight deterioration of the delay repeats due to clipping, which – in addition to the loss of high-end frequencies – used to be one of the main characteristics of historical tape delays.

Reverse

The Reverse delay is a great effect when a more mysterious, exotic delay style is required. Use the Feedback Hi-Cut parameter to soften the delay.

All Common Parameters

Please refer to the section “Delay – Introduction” for a description of this Delay's parameters.

The range of the Delay time for this delay type is 50ms to 800ms.

Lo-Fi

The Lo-Fi Delay will make your delays stand out. Try experimenting with the “Drive” parameter as well as the Feedback LoCut and Hi-Cut parameters to tailor the Lo-Fi sound to your exact needs.

In addition to the “common” parameters described in the introduction of the delay section, this delay has the following parameters:

Drive

Range: 0 to 24dB

The higher you set the Drive parameter, the more distorted the repeats become. The “drive” simulated by this effect has a very “analog” feel.

Ping Pong

The Ping Pong delay causes the delay to alternate between the left and right channels, resulting a very nice stereo feel. Use the Width parameter to determine how “stereo” you want this effect to be.

In addition to the “common” parameters described in the introduction of the delay section, this delay has the following parameters:

Width

Range: 0 to 100%

The Width parameter determines how far the left and right repetitions should spread from the center.

EFFECTS – DELAY

Dynamic Delay

The Dynamic Delay is a feature that was initially introduced in the well-recognized TC 2290. It allows the dynamics of the Input level to actively alter the Delay Output level, which leaves the source signal clear and undisturbed while you play. The Dynamic Delay delicately complements your performance. Use the Sense parameter to determine when the delays should re-surface. Use the Offset parameter to widen the stereo image.

In addition to the “common” parameters described in the introduction of the delay section, this delay has the following parameters:

Offset

Range: 0 to 200

This parameter offsets the Delay repeats in the right channel only. For a “wide” stereo effect, the delay in the two channels should not occur at exactly the same time. For a “wide” effect, a few milliseconds should do the trick. Using more than that will give you anything from a generous slap-back effect on the repeats to more extreme effects.

Sense – Sensitivity

Range: -50 to 0dB

The sensitivity parameter determines how soon the delay repeats should become audible in relation to the Input signal level. This parameter acts a threshold between your guitar signal and the delay repeats.

Damp

Range: 0 to 100dB

As explained in the introduction, the Dynamic Delay attenuates the delay repeats level based on the present Input. The Damp parameter sets the amount of attenuation.

Rel – Release

Range: 20 to 1000ms

Determines how fast the attenuation of the delay repeats is released.

Dual Delay

This true Dual Delay lets you set two independent delay taps, each with its own Tempo parameter, High and Low cut, as well as a “Pan” knob.

In addition to the “common” parameters described in the introduction of the delay section, this delay has the following parameters:

Pan1 & Pan2

Range: 50L to 50R

Sets the panning position of the delay repeats for delay lines 1 and 2.

EFFECTS – REVERB

Reverb Types

The G-System features four different Reverb classics. All types have the same editable parameters, but the reverbs' characteristics vary.

Spring

The Spring algorithm is designed to reproduce the sound of old spring reverbs, such as the ones used in vintage guitar amps.

Hall

The Hall algorithm simulates a rather large hall and preserves the natural characteristics of the source material. Excellent when you strive for a discrete Reverb with medium to long Decay times.

Room

The Living Room type simulates a relatively small, well furnished room. In such a room, many reflections are absorbed by soft materials, and the source signal is reflected and sustained mainly from the walls.

Plate

Before the digital era, either reverberating springs or large metallic plates were used to create reverb effects. Plate reverbs sound diffuse and bright. They can be used to make the processed signal “stand out”, rather than blend naturally.

These brief introductions should only give you a hint in terms of choosing the right one for a given application. Take some time to listen to the different types, experiment and don't be afraid to be innovative!

Common Reverb Parameters

Decay

Range: 0.1 to 20 seconds

The Decay parameter determines the length of the Reverb Diffuse Field. The length is defined as the time it takes for the Diffuse Field to decay approximately by 60dB.

PreDly – Pre Delay

Range: 0 to 100ms

This parameter defines a short Delay placed between the direct signal and the Reverb Diffuse field. Use Pre Delay to keep the source material clear and undisturbed from the more diffuse Reverb Diffuse Field arriving shortly after.

Shape

Range: Round, Square or Curved

The shape of the simulated room is of great importance to the reverb characteristics. Try the various shapes.

Size

Range: Small, Medium or Large

Though the Decay time can be altered from 0.1 to 20 seconds on all reverb types, selecting a predefined (room) size may get you closer to the sound you desire. To achieve a natural sounding emulation of a big room with long decay, select “Large”. Use the Medium and Small settings accordingly for simulations of smaller rooms.

Again: Building the perfect guitar sound is not always about doing the most obvious. You may find cool settings by swimming against the stream.

Hi Col & Lo Col – (High Color/Low Color)

Hi Color range:

Wool, Warm, Real, Clear, Bright, Crisp and Glass.

Lo Color range:

Thick, Round, Real, Light, Tight, Thin, NoBass

These parameters give you six variations of the reverb's

low and high frequency ranges.

The two Color parameters can really change the characteristics and style of the reverb – from “dark” and “ambient” to “crisp” and “bright”.

Hi Lev & Lo Lev – (High Level/Low Level)

Range: -25 to 25

Use the Hi Lev and Lo Lev parameters to emphasize or attenuate the selected Hi and Lo Color types.

Early

Range: -100 to 0dB

This parameter sets the level of the reverb’s initial reflections (early reflections).

RevLev – Reverb Level

Range: -100 to 0dB

This parameter sets the Level of the reverb’s diffuse field.

Diff – Diffuse

Range: -25 to 25

With this parameter, you can fine-tuning the density of the reverb’s diffuse field. It is set automatically when you select a Decay time and allows you to reduce flutter in the diffuse field to an absolute minimum.

Mix

Range: 0 to 100%

This parameter sets the relationship between the dry signal and the level of the effect in this Effect Block.

OutLev – Output Level

Range: -100 to 0dB

This parameter sets the overall Output level of this Effect Block.

Enable

Range: Off/On

The effect’s status. All settings are stored as part of the preset even if this particular effect is disabled.

EQ – Parametric

The G-System features a 3 band parametric equalizer. You can use this EQ either to shape the sound of individual presets or – in the Lock Mode set via Utility – as a “master EQ”.

For each band, the following parameters are available:

Gain

Range: -12dB to +12dB

Use this parameter to attenuate or boost the frequency range selected with the Freq(uecy) parameter.

Freq

Range: 20Hz to 20kHz

This parameter sets the center frequency of the frequency range that you want to attenuate or boost.

Width

Range: 0.1 to 4 octaves

This parameter sets the width of the frequency range around the frequency specified by the Freq(uecy) parameter.

Enable

Range: Off/On

The effect’s status. All settings are stored as part of the preset even if this particular effect is disabled.

EFFECTS – NOISE GATE

Noise Gate

Introduction

A noise gate is used to attenuate the signal when you don't play your guitar. This way you can mute all that hiss, hum and other noise coming from cables, old pedals etc.

Of course a Noise Gate is not the ultimate solution to noise problems. You should try to avoid noise in the first place. Noise can be introduced by a number of factors. Poor cables, poorly shielded single coil pickups and power supplies placed too close to signal cables are common problems that you can work around by experimenting.

However, a certain amount of noise will *always* be present in any guitar setup. The Noise Gate can help you attenuate this noise when you are not playing. Be careful, though, when setting the parameters Threshold and Release Rate. Too high a Threshold setting may result in the Gate not opening when you play the guitar softly. If Release time is too slow, the attack phase of the signal will be cut.

Optimum settings will vary depending on the signal present on the G-System's input, so you will most likely need different settings for Clean and Overdrive sounds.

Mode

Range: Hard – Soft

This parameter determines the basic characteristics of the Noise Gate, i.e. how fast it should attenuate/dampen the signal when it falls below Threshold.

Threshold

Range: -60dB to 0dB

The Threshold point determines at what point the Noise Gate should start dampening the signal.

To set this parameter, turn up the volume using your guitar's volume potentiometer, but do not play. Then turn up the Threshold value from -60dB to the point when the desired dampening is actually achieved.

If you configure the Noise Gate this way, you will need to set the Max Damping parameter (see below) to a value other than 0dB, as 0dB means "no damping".

Max. Damping

Range: 0dB to 90dB

This parameter determines how hard the signal should be attenuated when the signal level falls below the set Threshold.

Now you might think that you should always go for maximum dampening. However, consider the fact that you should also strive for a smooth transition from the "gated/attenuated" stage to the "open" stage. The more dBs must be released when opening the Gate, the more obvious the effect becomes. This means that you will have to experiment to fine-tune the Noise Gate to your sounds – there is no one-size-fits-all settings.

Speed – Release Speed

Range: 3dB/sec to 200dB/sec

The Release parameter determines how fast the signal is released when the Input signal rises above the Threshold point again. As a rule of thumb, this parameter should be set to a fairly high value.

Illustration

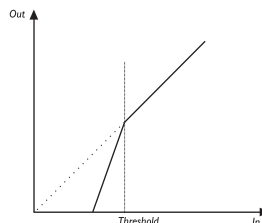

NG – Noise gate

Range: Off/On

The effect's status. All settings are stored as part of the preset even if the Noise Gate is disabled.

MIDI IMPLEMENTATION CHART

MIDI Implementation Chart for G-System – Version 1.0

Function		Transmitted	Recognized	Remarks
Basic Channel	Default	1	1	
	Changed	1 to 16	1 to 16	
Mode	Default			
	Messages Altered	X	X	
Note Number		X	X	
	True Voice	X	X	
Velocity	Note ON	X	X	
	Note OFF	X	X	
After Touch	Key	X	O	
	Channel	X	X	
Pitch Bend		X	O	
Control Change		0 to 127	0 to 127	
Prog Change		O	O	
	True#	0 to 127	0 to 127	
System Exclusive		O	O	
Common:	Song Pos	X	X	
	Song Sel	X	X	
	Tune	X	X	
System real time:	Clock	O	O	
	Commands	X	X	
Aux Messages:	Local ON/OFF	X	X	
	All Notes OFF	X	X	
	Active Sense	X	X	
	Reset	X	X	
Notes				

O: YES

X: NO

APPENDIX – FREQUENTLY ASKED QUESTIONS

Question - No signal on output?

On some specific user presets there is no signal in the output, although the Input VU-meter shows that signal is entering the unit.

Answer

This can occur if you set the Insert loop to "on" without having anything connected to it. Please set the insert loop to "off".

Question - G-System directly into a combo?

Is it possible to use the G-System straight into the front end of a small combo guitar amp without the use of a pre amp?

Answer

Yes this is possible, if the amp is used as a "power amp". If you need to use the drive of the combo, the pre-amp section of the combo should be inserted in the Insert loop of the G-System (loop 5) to take full benefit of the post effects of the G-System.

Question - How do I adjust the Input level?

What is the proper way to adjust the input level on my G-System? Should the meters be almost clipping?

Answer

You should leave some headroom (around 3dB) on the Input meter to avoid internal DSP overloads.

A DSP overload can happen anytime though, depending on how much you boost the signal inside the unit. If you boost the signal too much internally, the LEDs will light up, even though the input is not too loud.

You should be careful not to overloading the DSP. In analog equipment, overloads can produce harmonic distortion, which can make the sound "warmer". In digital equipment overloading just degrades the sound and creates loud clicks!

Question - Global bypass?

How can I bypass the G-System?

Answer

There is no Global Bypass parameter in the G-System. But you can assign an 'empty' preset to any customizable switch. The factory preset B9-5 is an "all-bypassed" preset.

Question - Control of several GFX01

Can one single G-System board control several GFX01 (the 1 unit processing module that is mounted under the G-System board itself)?

Answer

No, this is not possible. The G-System board can only control one GFX01 unit. However, via MIDI the G-System can send certain MIDI messages to other MIDI compatible devices.

Question - Volume Min value

My expression pedal is set to control the Volume parameter and though the Min. parameter is set much higher than 0, the "heel-down" position is still equal to "off".

Answer

This is intentional and how most people want the Volume control to work. If you need a minimum value different from "off" in "heel-down" position, we suggest you use a volume/expression pedal with an adjustable minimum value.

You will also find answers to the most frequently asked questions in our support database TC Support Interactive (located at www.tcelectronic.com).



PRESET LIST

MIDI #	Bank	Preset	Preset Name	MIDI #	Bank	Preset	Preset Name
0	A0	1	Scotty's Blues	35	A7	1	Pure Liverpool
1		2	Sheryl's Detune	36		2	Reverberated
2		3	So Scho	37		3	Vintage Phaser
3		4	Gilmore's Delays	38		4	Filtered Rockabilly
4		5	Light Detune	39		5	Phasing The Facts
5	A1	1	Lofi Delay	40	A8	1	70's Tape Flange
6		2	Echo Filters	41		2	Slow Modulation
7		3	TouchWah	42		3	Tremo Vibe
8		4	Filtered Tape Delay	43		4	Resonance Vibration
9		5	Straight Up Lead	44		5	Natural Vibration
10	A2	1	Auto Wah	45	A9	1	Bluebox Echo's
11		2	TouchWah Verb	46		2	Who Said Skysaw?
12		3	80's Hall of Fame	47		3	Sus4 DreamVerb
13		4	Auto Formant	48		4	Sus4 Taped Up
14		5	Straight Wah wah	49		5	Rise and Shine
15	A3	1	Soft Tremolo	50	B0	1	Simply Chorus
16		2	Filtered Chopper	51		2	Slow Flange
17		3	Tremo Oct	52		3	Vibra Room
18		4	Machine Gun AI	53		4	Message in a Bottle
19		5	Comp'ed Tremolo	54		5	Gold Plate
20	A4	1	All But Lee ...	55	B1	1	Chicken Dance
21		2	Shadows Of Mr Marvin	56		2	Funky Music Verb
22		3	Chet A's Own	57		3	Play That Funk Music
23		4	Mr. Montgomery Lead	58		4	Clean Cowboy
24		5	Slapback	59		5	Chicken Picking
25	A5	1	Right On The Edge	60	B2	1	Reso Tremolo
26		2	Dynamic Delay	61		2	Funky Filters Revers
27		3	Comp'ed Dual Delay	62		3	Pie In The Sky
28		4	Add Fuzz & Its There	63		4	Whammy 2 Oct Up
29		5	Reversed Phase Dly	64		5	Whammy 1 Oct Down
30	A6	1	Deep Bass	65	B3	1	Clean Comp
31		2	Deep Canny Bass	66		2	Slow Release Comp
32		3	Funky Octaver	67		3	Clean Picking Comp
33		4	Octa Comp	68		4	Clean Comped Plate
34		5	Synthized	69		5	Sustaining Comp

PRESET LIST

MIDI #	Bank	Preset	Preset Name
70	B4	1	Phase Off
71		2	Talk the Talk
72		3	Funky Thang
73		4	Straight Octaver
74		5	LoFi Filters
75	B5	1	T Petty Chorus
76		2	Bluesey Lead
77		3	Vibra Wah
78		4	Stuck In the Middle
79		5	Funky Chorus Rhythm
80	B6	1	Subtle Acoustic
81		2	Acoustic Detune
82		3	Vibrato – Sweet
83		4	Soft Vibrato
84		5	Sustained Chorus
85	B7	1	Jazz Ballad
86		2	And All That Jazz
87		3	Blues Room
88		4	The Good, Bad & Ugly
89		5	Telephone Delays
90	B8	1	Clean Chorus Verb
91		2	Rockabilly Slap
92		3	Rock'n Roll Spring
93		4	Reverb & Delays
94		5	Guitar Hero
95	B9	1	Distant Vibrato
96		2	Ping Pong pong pong
97		3	Slow Hi Range Phase
98		4	Double Filters
99		5	All Bypassed

TECHNICAL SPECIFICATIONS

Instrument Inputs

Connectors:	Two 1/4" phone jack, pseudo-balanced
Impedance:	1 Mohm
Max. Input Level:	18 dBu
Min. Input Level for 0 dBFS:	-6 dBu
Sensitivity:	-6dBu to +18 dBu

Loop 1-4

Connectors:	Two 1/4" phone jacks x 4
Impedance, input/output:	91 kOhm/100 Ohm
Max. Output Level:	12 dBu
Output Ranges:	6 to 10 dBu

Insert

Connectors:	Two 1/4" phone jacks
Impedance, input/output:	24 kOhm(Balanced 35 kOhm)/ 100Ohm(Balanced 200 Ohm)
Max. Output Level:	12 dBu
Output Ranges:	6 to 10 dBu

Analog Outputs (L/R)

Connectors:	Two 1/4" phone jacks
Impedance:	100 Ohm (Balanced 200 Ohm)
Max. Output Level:	12 dBu
Output Ranges:	0 to 10 dBu

Digital Outputs

Connectors:	RCA Phono (S/PDIF)
Formats:	S/PDIF (24 bit), EIAJ CP-340, IEC 958, 75Ohm
Sample Rate:	44.1 kHz

System Performance

Frequency Response:	typ. : +0.0/-0.4 dB, 20 Hz to 20 kHz
Dynamic Range:	typ.: > 95 dB, 20Hz to 22kHz, 0dBFS
THD:	typ.: < -80 dB, 20Hz to 22kHz, -1dBFS
A to D Conversion:	24 bit, 128 x oversampling bitstream, DSR
D to A Conversion:	24 bit, 128 x oversampling bitstream, DSR

EMC

Complies with:	EN 55103-1 and EN 55103-2 FCC part 15, Class B, CISPR 22, Class B
----------------	--

Safety

Certified to:	IEC 60065 / EN 60065/ UL 60065 / CSA E60065
---------------	--

Environment

Operating Temperature:	32° F to 122° F (0° C to 50° C)
Storage Temperature:	-22° F to 167° F (-30° C to 70° C)
Humidity:	Max. 90 % non-condensing

Control Interface

MIDI:	In/Out: 5 Pin DIN
USB:	USB 1.1, type B
Pedal (Exp and Vol):	Four 1/4" stereo phone jack (2 on GFX01, 2 on Control Board)
Relay closure (seperate tip and ring connection to sleeve):	4 relays on two 1/4" stereo phone jack for amp Switching

Misc

DC output:	4 x 9VDC outputs, 200mA totally, Shield(+) Pin(-)
------------	--

General

Finish:	Anodized aluminum front Plated and painted steel chassis
Display:	2x20 character STN-LCD display + 20x7 Dot-Matrix
Footswitches:	18 Illuminated Footswitches (6 with build-in Rotary Encoders)

Dimensions:	20.2" x 10.5" x 4.1" (512.9mm x 265.9mm x 103.4mm)
Weight:	17.2 lb. (7.83 kg)

Mains

Voltage:	100 to 240 VAC, 50 to 60 Hz (auto-select)
Power Consumption:	<20 W
Warranty Parts and labor:	According to EU regulations

Technical specifications are subject to change without notice.